



Manual

# WERMA-WIN

Version: 5.1 - 11/2020

310.860.001

## PROCESS OPTIMISATION SYSTEMS

You need a system to measure unproductive times to identify hidden potential in production, logistics or mail-order retail – whether at manual workstations, shipping workstations or in automated production.

### SmartMONITOR – the solution for factories

The clever MDE alternative for manufacturing companies.

- Identify and document errors and unproductive times more quickly
- Shorten response times and avoid downtimes
- Highlight opportunities for improving processes and productivity using reports

### AndonSPEED – for shipping logistics

The ideal call-for-action system that makes permanent time savings possible.

- Fast troubleshooting
- Intelligent reporting for long-term improvement
- Makes potential optimisation visible

#### Legal notices

Any mention of company names is solely for instruction purposes. Reference to actual existing organisations is not intended, with the exception of the companies below. The following companies and brands are mentioned in the Help Manual:

- Microsoft, Windows 10, Windows 8.1, Windows 8 and Excel are trademarks of Microsoft Corporation
- Adobe Acrobat Reader is a trademark of Adobe Systems Software Ireland Ltd.

WERMA reserves the right to make technical changes to the product and accepts no responsibility for mistakes or printing errors which may be contained in this documentation.

© Copyright 2020, WERMA Signaltechnik GmbH + Co.KG.

All rights reserved.

#### WERMA Signaltechnik GmbH + Co.KG

78604 Rietheim-Weilheim, Germany

Phone: +49 (0)7424 / 9557-222

Fax: +49 (0)7424 / 9557-44

*support@werma.com*

*www.werma.com*

# Table of Contents

<b>1</b>	<b>Installation</b>	<b>6</b>
1.1	Installing WERMA-WIN	6
1.2	Installing the WERMA-WIN database	8
1.2.1	Installing the database locally	9
1.2.2	Connecting to an existing database	10
1.2.3	IT expert installation	10
1.3	Firewall configuration	18
1.4	Manual driver installation	18
<b>2</b>	<b>Activating WIN devices</b>	<b>22</b>
2.1	WIN master	22
2.2	WIN ethernet master	24
2.2.1	Automatically obtaining an IP address via DHCP	27
2.2.2	Using a static IP address	28
2.2.3	Advanced network configuration	29
2.3	WIN slave	31
2.4	WIN slave performance	33
2.5	WIN slave control	35
2.6	Changing transmission channel	38
2.7	Firmware update	40
2.8	Swapping WIN master and WIN ethernet master	41
<b>3</b>	<b>Program functions</b>	<b>45</b>
3.1	Control station	45
3.1.1	Control station display	45
3.1.2	Views	49
3.1.3	Configuration of the WERMA-WIN devices	54
3.1.4	Resetting the quantity counter	70
3.1.5	Manual control	70
3.1.6	Status change message	70
3.1.7	Status transmission	72
3.1.8	Report	75
3.2	Productivity	75
3.2.1	Views	76
3.2.2	Productivity view	79
3.2.3	Report	84
3.3	Runtime	85
3.3.1	Views	85
3.3.2	Runtime display	87
3.3.3	Notes/Fault conditions	91
3.3.4	Job	94

3.3.5	Report .....	95
3.4	Job .....	95
3.4.1	Job overview .....	96
3.4.2	Job details .....	97
3.4.3	Entering jobs .....	100
3.4.4	Starting jobs .....	106
3.4.5	Completing jobs .....	108
3.4.6	Activating Auto jobs .....	108
3.4.7	Disabling Auto jobs .....	108
3.4.8	Editing jobs .....	108
3.4.9	Correction of a completed job .....	109
3.4.10	Deleting jobs .....	110
3.4.11	Duplicating jobs .....	110
3.4.12	Report .....	111
3.5	Control .....	112
3.5.1	Overview of rules .....	113
3.5.2	Defining new rules .....	114
3.5.3	Enabling a rule .....	128
3.5.4	Disabling a rule .....	128
3.5.5	Editing a rule .....	128
3.5.6	Duplicating a rule .....	129
3.5.7	Deleting a rule .....	130
3.6	Routing .....	131
3.6.1	Displaying connection status .....	132
3.6.2	Optimising wireless communication .....	133
3.7	Settings .....	133
3.7.1	General .....	134
3.7.2	Views .....	136
3.7.3	Status transmission .....	139
3.7.4	Sound .....	145
3.7.5	Reports .....	146
3.7.6	WIN devices .....	147
3.7.7	Database .....	148
3.7.8	Shifts .....	151
3.7.9	Fault conditions .....	155
3.7.10	Functions .....	157
3.8	Reports and exports .....	160
3.8.1	Pasting a watermark .....	162
3.8.2	Deleting a watermark .....	163
3.8.3	File formats .....	164

## **4 Automation interfaces ..... 169**

4.1	XML interface .....	169
4.1.1	Export .....	169

4.1.2	Import .....	178
4.1.3	Interface status .....	186
4.2	WINtoApplication .....	187
4.2.1	Adding a job .....	188
4.2.2	Editing a job .....	192
4.2.3	Duplicating a job .....	196
4.2.4	Enabling or disabling individual jobs .....	200
4.2.5	Enabling or disabling all jobs .....	200
4.2.6	Deleting jobs .....	201
4.2.7	Exporting jobs .....	201
4.2.8	Importing jobs .....	201
4.2.9	History .....	202
4.2.10	Settings .....	202
4.2.11	Exiting WINtoApplication .....	202
4.3	WERMA-WIN CLI Tool .....	203
<b>5</b>	<b>Fault diagnostics .....</b>	<b>205</b>
5.1	WIN slave, WIN slave performance, WIN slave control .....	205
5.2	WIN slave control .....	205
5.3	WIN master .....	206
5.4	WIN ethernet master .....	207
<b>6</b>	<b>Software update .....</b>	<b>208</b>
<b>7</b>	<b>System requirements .....</b>	<b>209</b>
7.1	Network stability and security .....	210
<b>8</b>	<b>Keyboard shortcuts .....</b>	<b>211</b>
8.1	Windows standard .....	211
8.2	General .....	211
8.3	Control station .....	212
8.4	Productivity .....	212
8.5	Runtime .....	213
8.6	Job .....	213
8.7	Control .....	214
8.8	Routing .....	214
<b>9</b>	<b>FAQ – Frequently Asked Questions .....</b>	<b>215</b>

# 1 Installation

WERMA-WIN is installed first during installation. The WERMA-WIN database is then installed and set up or a connection is made to an existing database.

---

**i** Administrator rights are needed to install WERMA-WIN. No administrator rights are needed to use WERMA-WIN.

---

**i** The WERMA-WIN Client can be installed, refreshed and uninstalled unattended. For information about this, refer to the Docs subdirectory in the installation directory of the server application.

---

## 1.1 Installing WERMA-WIN

1. Make sure that the necessary *system requirements* are met.
2. Download the latest version of WERMA-WIN at [www.werma.com/win](http://www.werma.com/win).
3. Extract the downloaded ZIP file.
4. Double-click on the **WERMA-WIN-x-x-x-xxx.exe** file to start the installation.  
→ The installation wizard starts.

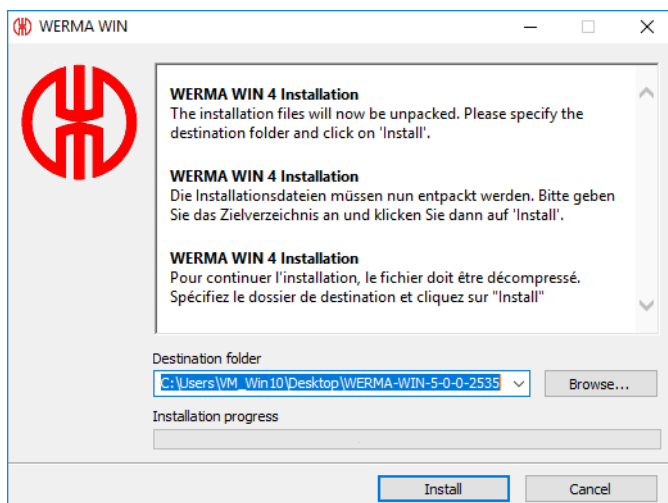

5. Follow the instructions in the installation wizard.  
→ Once the installation assistant has ended, the assistant to install the WERMA-WIN database appears.

WERMA-WIN database setup

Database setup

Please select...

**Install database**



Install the WERMA-WIN database and Server Service on this PC (1 x per network)

**Connect to existing database**



Connect to an existing database and Server Service via a WERMA Link File

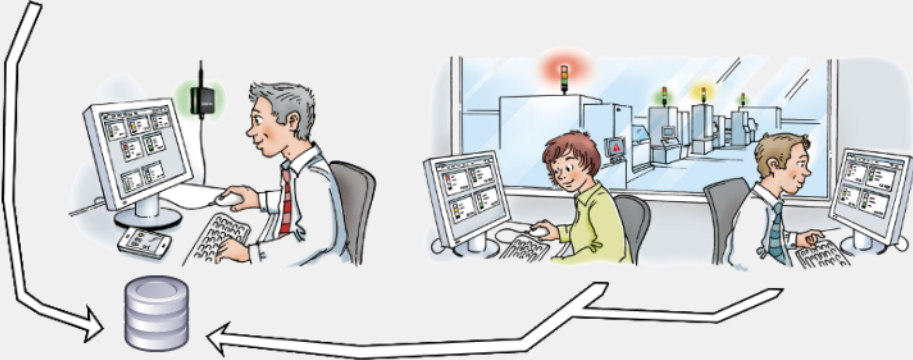

**IT expert installation**  
Further installation options

**Next**  
OK

## 1.2 Installing the WERMA-WIN database

There are three options available to you to install the WERMA-WIN database.

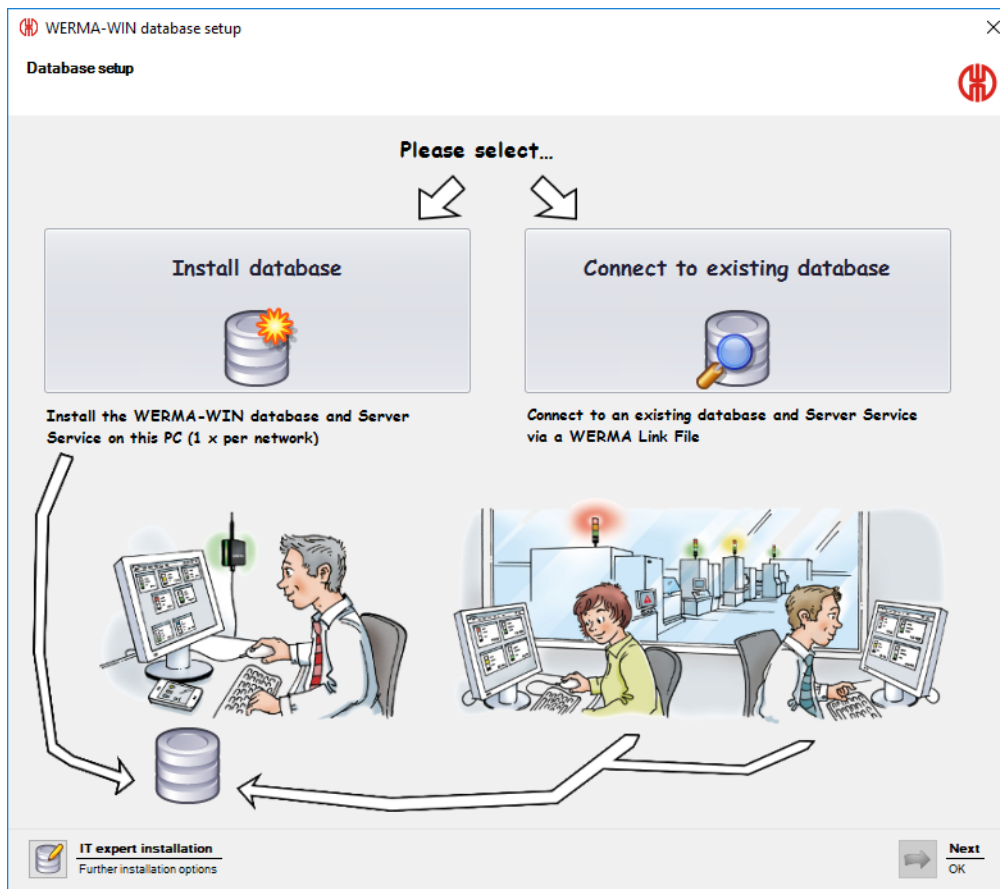

*Install the database locally:*

- The WERMA-WIN database is installed locally on the PC on which WERMA-WIN is installed.

*Connect to existing database:*

- A connection to an existing WERMA-WIN database is established using a link file previously installed.

*IT expert installation:*

- Establishment of a connection to a WERMA-WIN database on another desktop PC.
- Establishment of a connection to an empty Microsoft SQL server database in the network.
- Establishment of a connection to a Microsoft SQL server database in the network already containing WERMA-WIN data.



## 1.2.1 Installing the database locally

**i** To access the WERMA-WIN database, WERMA-WIN creates a user and an associated password with the following data:

- User: wermawin
- Password: Tyz19\$Lx50WsR3Ed7m

**i** The **WERMA-WIN 4 Server Service** and the **WERMA WIN 4 Connector Service** are both installed when the WERMA-WIN database is installed. These services run in the background when the PC is switched on. All collected WERMA-WIN data is written to the WERMA-WIN database without WERMA-WIN running and a user being logged on.

1. Click on **Install database**.

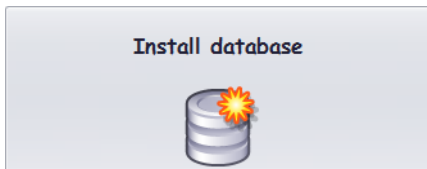

2. Click on **Next**.

→ The WERMA-WIN database is installed locally on the PC.

→ Once the database has been installed, a window appears in which to save the link file.

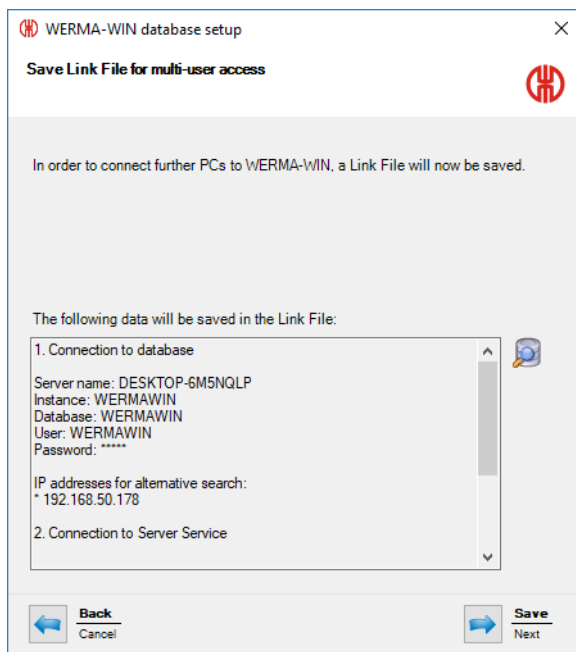

3. Click on **Save** to save the link file.

- 
- i** The link file lets you connect other workplaces to the WERMA-WIN database.
- 

## 1.2.2 Connecting to an existing database

---

- i** The **WERMA WIN 4 Connector Service** is installed when connecting to the existing WERMA-WIN database. This service runs in the background when the PC is switched on. All collected WERMA-WIN data from the connected WIN master is written to the WERMA-WIN database without WERMA-WIN running and a user being logged on.
- 

1. Click on **Connect to existing database**.

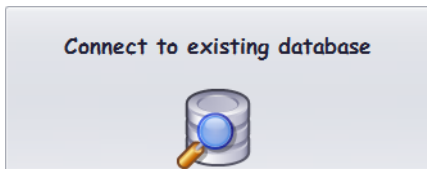

2. Click on **Next**.
  3. Open the link file.
    - The installation wizard checks the connection settings and establishes the connection to the existing WERMA-WIN database.
- 

- i** The link file can be *created* on the available WERMA-WIN installation.
- 

## 1.2.3 IT expert installation

1. Click on **IT expert installation**.
  - The **WERMA-WIN database setup** window appears.

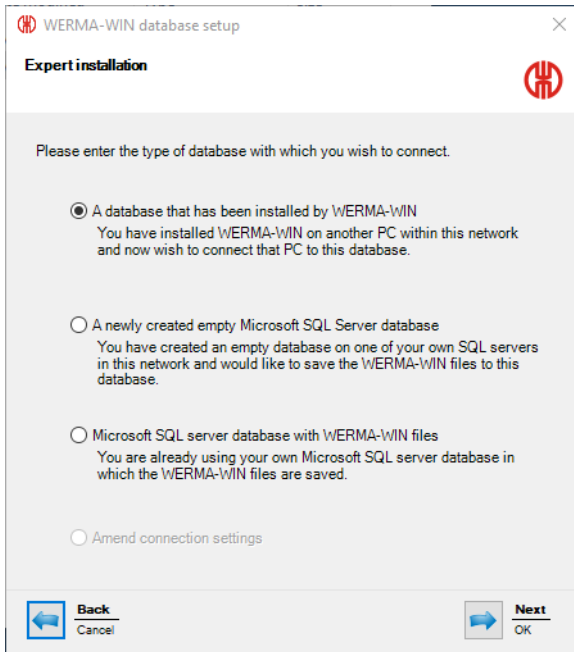

IT expert installation offers the following options:

- Use of the database that has been installed by WERMA-WIN
- Use of a newly created empty Microsoft SQL server database
- Use of a Microsoft SQL server database with WERMA-WIN files

### 1.2.3.1 Use of a database that has been installed by WERMA-WIN

1. Select **A database that has been installed by WERMA-WIN** option.
2. Click on **Next**.

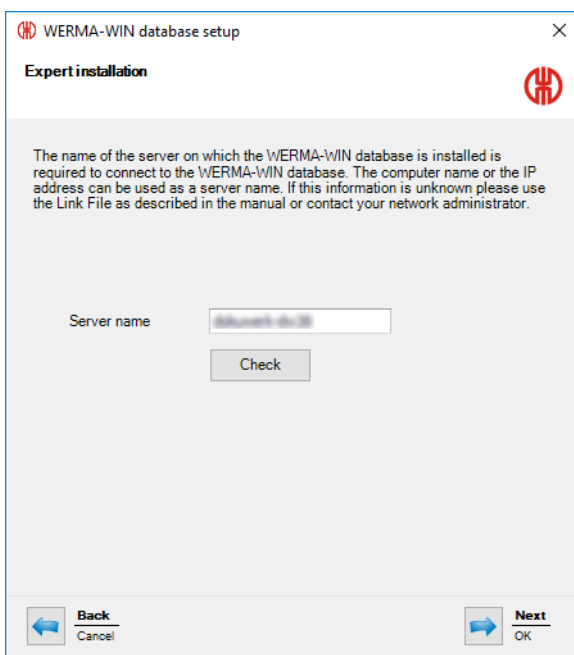

3. In the **Server name** field, enter the name of the server on which the WERMA-WIN database has been installed.

 The server name can be found in the WERMA-WIN link file (.wde) saved when installing the WERMA-WIN database.

4. Click on **Next**.

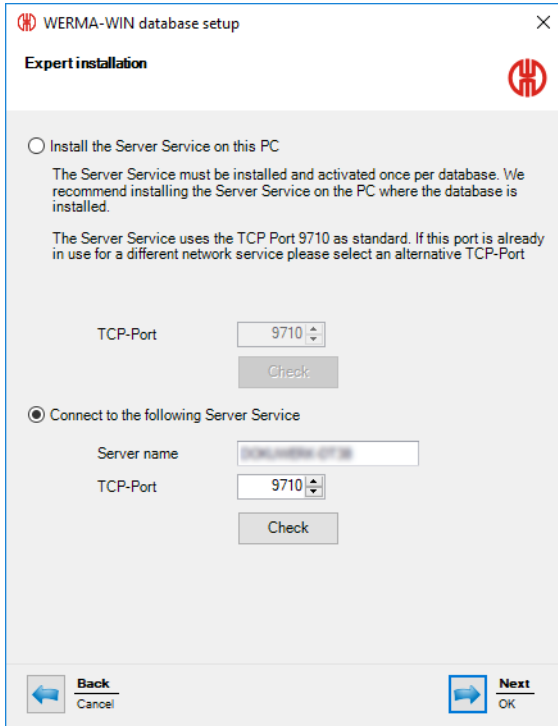

The screenshot shows the 'Expert installation' dialog box for WERMA-WIN database setup. It has two radio button options: 'Install the Server Service on this PC' (unselected) and 'Connect to the following Server Service' (selected). The first option includes a 'Check' button and a 'TCP-Port' dropdown menu set to 9710. The second option includes a 'Server name' text field containing 'WERMA-WIN-0718', a 'TCP-Port' dropdown menu set to 9710, and a 'Check' button. At the bottom, there are 'Back Cancel' and 'Next OK' buttons.

5. Select whether the **WERMA WIN 4 Server Service** is to be installed on this computer or whether you wish to establish a connection to an existing server service.

## Installing the WERMA WIN 4 Server Service

If the **WERMA WIN 4 Server Service** is to be installed on this computer:

1. Select **Install the Server Service on this PC** option.

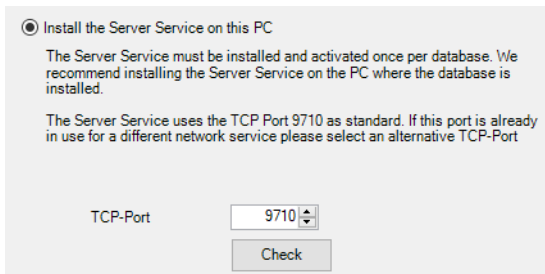

This screenshot shows the same dialog box as above, but with the 'Install the Server Service on this PC' radio button selected. The 'Connect to the following Server Service' option is now unselected. The 'TCP-Port' dropdown menu is still set to 9710 and the 'Check' button is visible.

2. You may need to change the server service TCP port in the **TCP port** field.
3. Click on **Next**.  
→ The connection to the WERMA-WIN database is created.

## Connection to an existing server service

If a connection is to be made to an existing server service:

1. Select **Connect to the following Server Service** option.

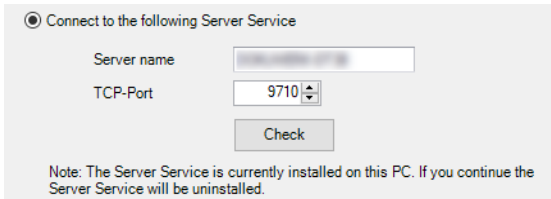

2. In the **Server name** field, enter the name of the server on which the server service has been installed.
3. Enter the server service TCP port in the **TCP-Port** field.
4. Click on **Next**.  
→ The connection to the WERMA-WIN database is created.



The **WERMA WIN 4 Connector Service** is installed during installation. This service runs in the background when the PC is switched on. All collected WERMA-WIN data from the connected WIN master is written to the WERMA-WIN database without WERMA-WIN running and a user being logged on.

### 1.2.3.2 Using a newly created empty Microsoft SQL server database

#### Requirements:

- An empty database has been set up on the Microsoft SQL server.
- A corresponding database user is linked to the database login.
- The database meets the following requirements:

Compatible from:	Microsoft SQL Server 2008
Recommendation:	Microsoft SQL Server 2014
Collation	Latin1_General_CI_AS
Role membership:	db_datareader db_datawriter db_ddladmin or db_owner

1. Select **A newly created empty Microsoft SQL server database** option.
2. Click on **Next**.

WERMA-WIN database setup

**Expert installation**

Please enter the database server connection settings.

The Server name is the name of the computer on which you have installed SQL Server for WERMA WIN. In the Instance name box, enter the name of the instance of SQL Server that you want to use for WERMA WIN. Alternatively, you can combine these as 'Servername\instancename' in the Server name box

If you have not specified an instance name for your SQL Server installation, leave the Instance name box empty.

This information is available from your network administrator.

Server name  (e.g. srv-sqldb-01)

Instance name  (e.g. WERMAWIN)

Database  (e.g. WERMAWIN)

User name  (e.g. WERMAWIN)

Password  (e.g. Tyz19\$lx50WsR3Ed7m)

Cancel  OK

3. Enter the access data for the empty database in the appropriate fields.

You do not have to complete the **Instance name** field.

4. Click on **Next**.

WERMA-WIN database setup

**Expert installation**

Install the Server Service on this PC

The Server Service must be installed and activated once per database. We recommend installing the Server Service on the PC where the database is installed.

The Server Service uses the TCP Port 9710 as standard. If this port is already in use for a different network service please select an alternative TCP-Port

TCP-Port

Connect to the following Server Service

Server name

TCP-Port

Cancel  OK

5. Select whether the **WERMA WIN 4 Server Service** is to be installed on this computer or whether you wish to establish a connection to an existing server service.

### Installing the WERMA WIN 4 Server Service

If the **WERMA WIN 4 Server Service** is to be installed on this computer:

1. Select **Install the Server Service on this PC** option.

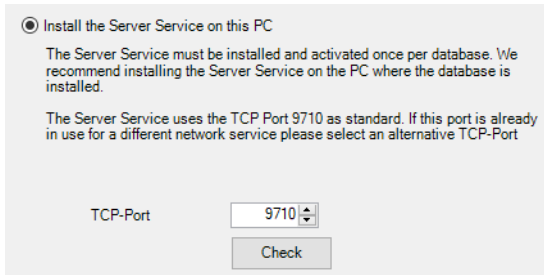

Install the Server Service on this PC

The Server Service must be installed and activated once per database. We recommend installing the Server Service on the PC where the database is installed.

The Server Service uses the TCP Port 9710 as standard. If this port is already in use for a different network service please select an alternative TCP-Port

TCP-Port:

2. You may need to change the server service TCP port in the **TCP Port** field.
3. Click on **Next**.  
→ The connection to the database is created.

### Connection to an existing server service

If a connection is to be made to an existing server service:

1. Select **Connect to the following Server Service** option.

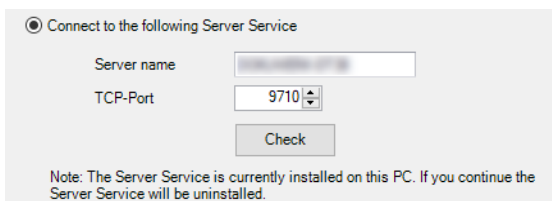

Connect to the following Server Service

Server name:

TCP-Port:

Note: The Server Service is currently installed on this PC. If you continue the Server Service will be uninstalled.

2. In the **Server name** field, enter the name of the server on which the server service has been installed.
3. Enter the server service TCP port in the **TCP-Port** field.
4. Click on **Next**.  
→ The connection to the database is created.



The **WERMA WIN 4 Connector Service** is installed during installation. This service runs in the background when the PC is switched on. All collected WIN data from the connected WIN master is written to the WIN database without WIN software running and a user being logged on.

### 1.2.3.3 Using a Microsoft SQL server database with WERMA-WIN files

1. Select **Microsoft SQL server database with WERMA-WIN data** option.
2. Click on **Next**.

WERMA-WIN database setup

**Expert installation**

Please enter the database server connection settings.

The Server name is the name of the computer on which you have installed SQL Server for WERMA WIN. In the Instance name box, enter the name of the instance of SQL Server that you want to use for WERMA WIN. Alternatively, you can combine these as 'Servername\instancename' in the Server name box

If you have not specified an instance name for your SQL Server installation, leave the Instance name box empty.

This information is available from your network administrator.

Server name  (e.g. srv-sqldb-01)

Instance name  (e.g. WERMAWIN)

Database  (e.g. WERMAWIN)

User name  (e.g. WERMAWIN)

Password  (e.g. Tyz19\$lx50WsR3Ed7m)

Cancel  OK

3. Enter the access data for the empty database in the appropriate fields.

You do not have to complete the **Instance name** field.

4. Click on **Next**.

WERMA-WIN database setup

**Expert installation**

Install the Server Service on this PC

The Server Service must be installed and activated once per database. We recommend installing the Server Service on the PC where the database is installed.

The Server Service uses the TCP Port 9710 as standard. If this port is already in use for a different network service please select an alternative TCP-Port

TCP-Port

Connect to the following Server Service

Server name

TCP-Port

Cancel  OK



5. Select whether the **WERMA WIN 4 Server Service** is to be installed on this computer or whether you wish to establish a connection to an existing server service.

### Installing the WERMA WIN 4 Server Service

If the **WERMA WIN 4 Server Service** is to be installed on this computer:

1. Select **Install the Server Service on this PC** option.

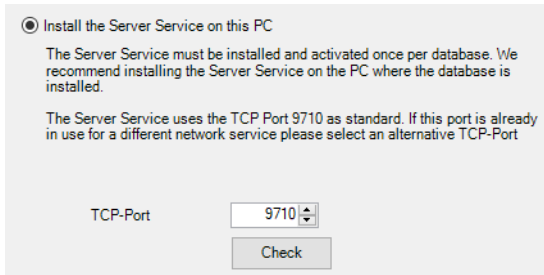

Install the Server Service on this PC

The Server Service must be installed and activated once per database. We recommend installing the Server Service on the PC where the database is installed.

The Server Service uses the TCP Port 9710 as standard. If this port is already in use for a different network service please select an alternative TCP-Port

TCP-Port:

2. You may need to change the server service TCP port in the **TCP port** field.
3. Click on **Next**.  
→ The connection to the WERMA-WIN database is created.

### Connection to an existing server service

If a connection is to be made to an existing server service:

1. Select **Connect to the following Server Service** option.

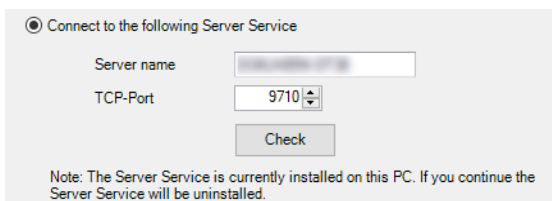

Connect to the following Server Service

Server name:

TCP-Port:

Note: The Server Service is currently installed on this PC. If you continue the Server Service will be uninstalled.

2. In the **Server name** field, enter the name of the server on which the server service has been installed.
3. Enter the server service TCP port in the **TCP-Port** field.
4. Click on **Next**.  
→ The connection to the WERMA-WIN database is created.



The **WERMA WIN 4 Connector Service** is installed during installation. This service runs in the background when the PC is switched on. All collected WERMA-WIN data from the connected WIN master is written to the WERMA-WIN database without WERMA-WIN running and a user being logged on.

---

## 1.3 Firewall configuration

All necessary port enables are configured in the Windows firewall by default when WERMA-WIN is installed. If you are using additional firewall or network products, it may be necessary to adapt them manually.

1. Make sure that the following network connections are not blocked:

Source	Destination	Type	Port	Remark
Server Client	Microsoft SQL Server	UDP/TCP	–	WERMA recommends allowing all network connections for <code>sqlservr.exe</code> and <code>sqlbrowser.exe</code> in the Microsoft SQL Server Installation.  Refer to the administration manual for the Microsoft SQL server for a different configuration.
Server Client	Server	TCP	9710*	Database connection to the <b>WERMA WIN 4 Server Service</b>
Server	WIN ethernet master	TCP	80*	http data connection
Server	WIN ethernet master	UDP broadcast	5000	Retrieval of device information
Server	External mail server	TCP	25*	Mail sent by SMTP to the configured server
Server	www.werma-win.com**	TCP	443	Mail sent using the integrated mail function. Configuration of a web proxy is possible.
Server Client	www.werma.com** www.werma-win.com**	TCP	80	Update testing, retrieval of the Online Help and Contact site

\* Can be configured differently in WERMA-WIN on *commissioning* of the WERMA-WIN devices.

\*\* We recommend enabling access to other subdomains for future updates of WERMA-WIN.

## 1.4 Manual driver installation

---

 Manual driver installation is only required if the device driver software has not been automatically installed during connection of a WERMA-WIN device.

---

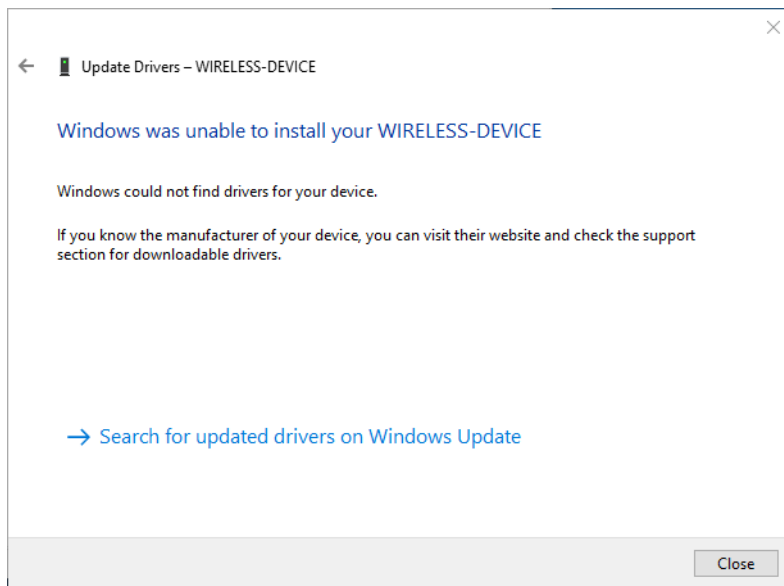

### 1. Open **Device Manager**.

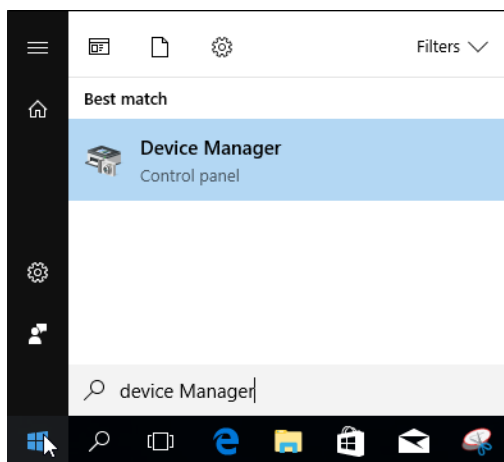

→ The **Device Manager** window appears.

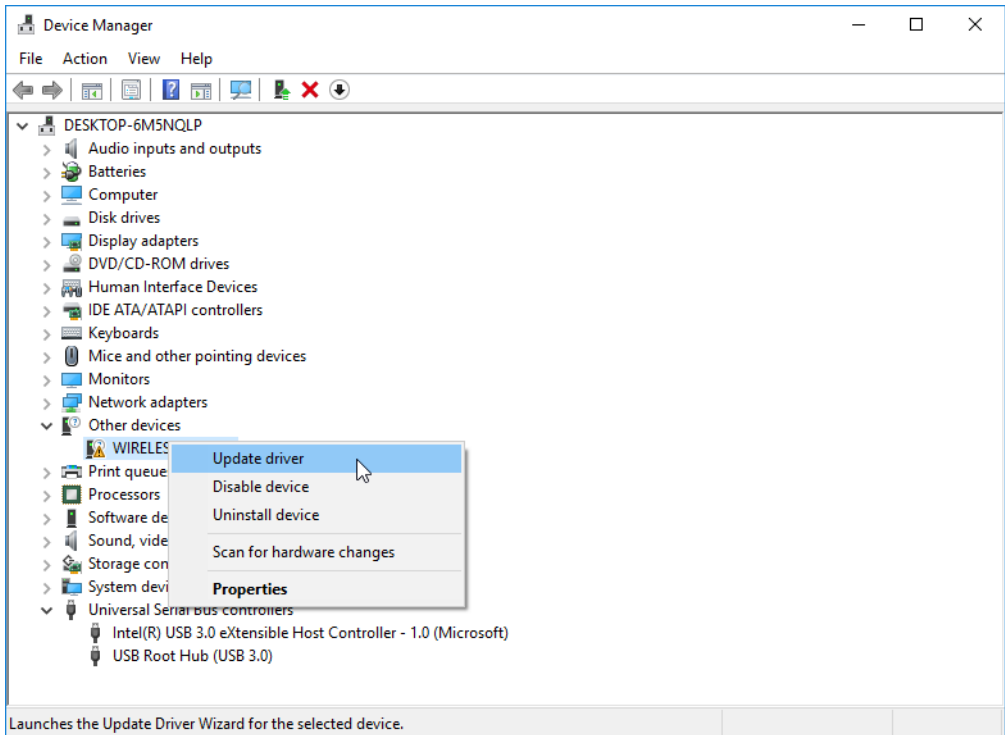

2. Right-click **WIRELESS DEVICE**.
3. Select **Update driver** in the pop-up menu.

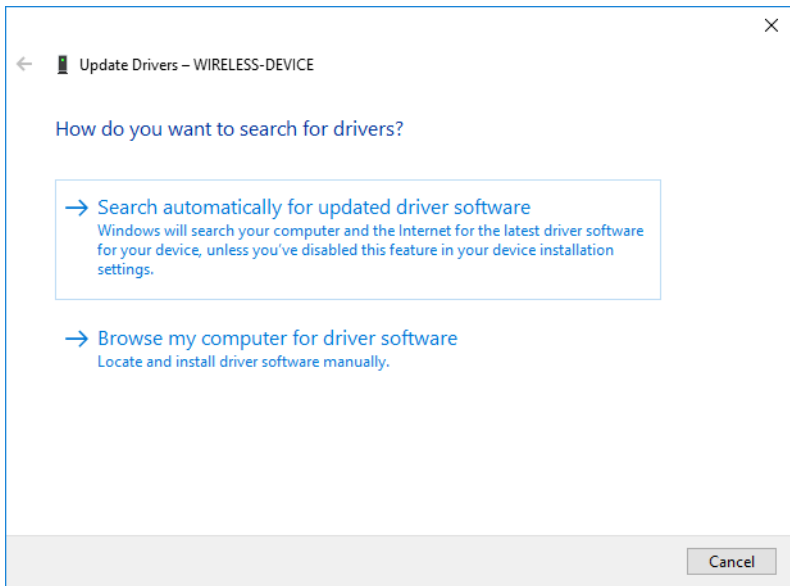

4. Click **Browse my computer for driver software**.

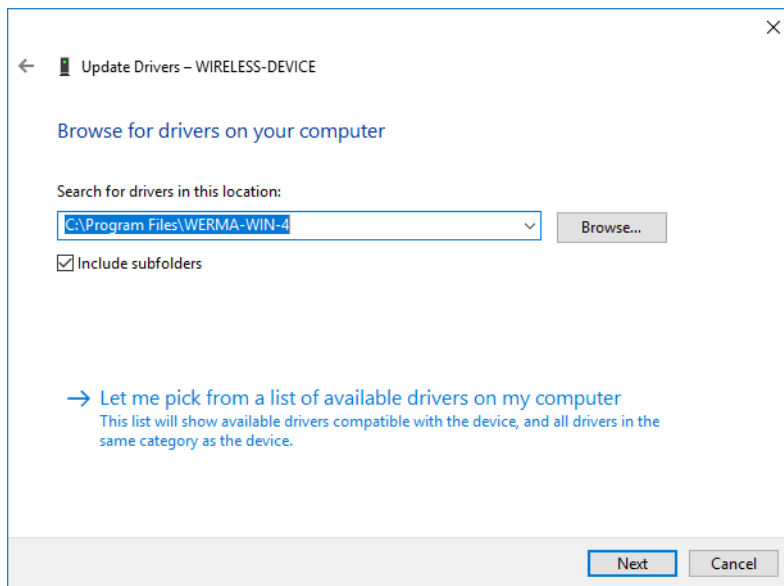

5. Click on **Browse**.
6. Navigate to the WERMA-WIN installation directory and open the Driver folder.
7. Click on **Next**.  
→ The device drivers are installed.

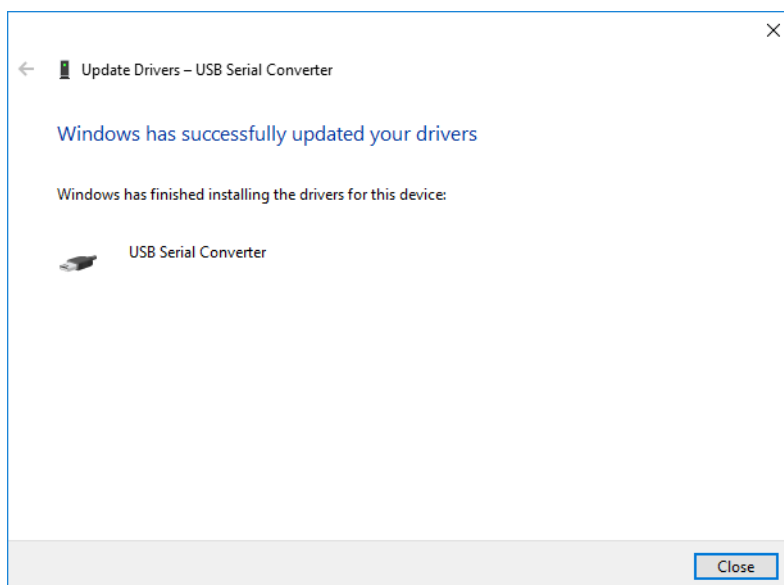

8. Once successfully installed, click on **Close** to close the hardware wizard.  
→ The WERMA-WIN device is now ready for operation.

## 2 Activating WIN devices

WIN master or WIN ethernet master must be connected to a PC and configured before WERMA-WIN data from the signal towers can be received. WIN slaves should then be configured and assigned to a WIN master or WIN ethernet master.

### 2.1 WIN master

1. Click on **Activation** in the toolbar.

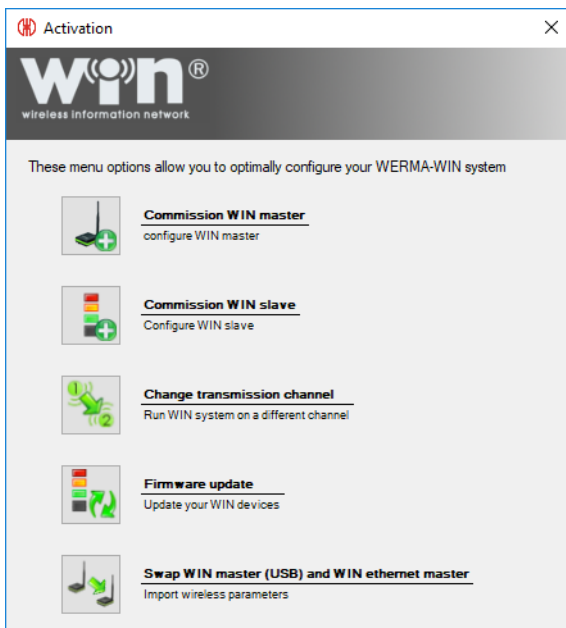

2. Click on **Commission WIN master**.



3. Connect WIN master to the PC and click on **Search**.  
→ WERMA-WIN searches for the connected WIN master.



4. Once WIN master has been recognised, click on **Next**.

---

 A message appears if a new firmware version is available. Click **Yes** to install the new firmware version.

---



5. Enter the description of the WIN master in the **Name** field.



The transmission channel of the individual systems can be changed to enable the best possible radio connection when several WERMA-WIN systems are run in parallel. WERMA recommends only operating one WIN master per transmission channel.

6. Select another transmission channel in the **Channel** selection list if necessary.

7. Click on **Next**.

→ The configuration is transferred to the WIN master.

## 2.2 WIN ethernet master

1. Click on **Activation** in the toolbar.



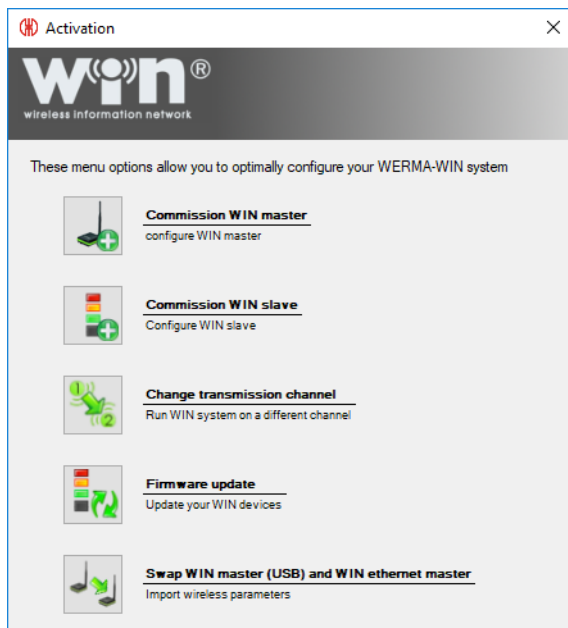

2. Click on **Start up WIN master.**



3. Use the USB cable to connect WIN ethernet master to the computer and click on **Search**.  
→ WERMA-WIN searches for the connected WIN ethernet master.

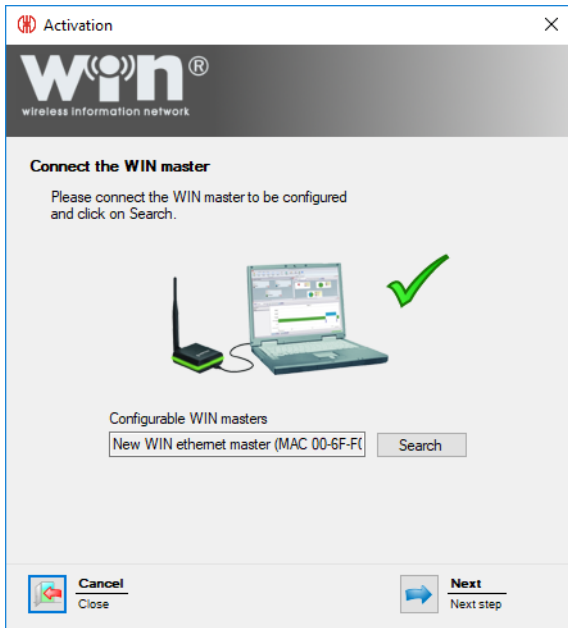

4. After WIN ethernet master has been recognised, click on **Next**.

 A message appears if a new firmware version is available. Click **Yes** to install the new firmware version.



5. Enter the description of the WIN ethernet master in the **Name** field.

 The transmission channel of the individual systems can be changed to enable the best possible radio connection when several WERMA-WIN systems are run in parallel. WERMA recommends only operating one WIN master per transmission channel.

6. Select another transmission channel in the **Channel** selection list if necessary.
7. Click on **Next**.

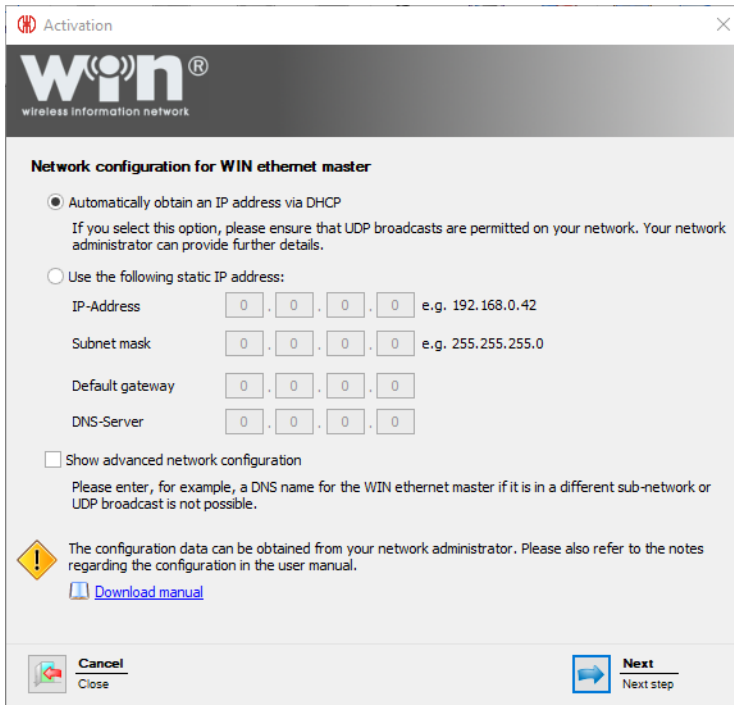

**Activation**

**win®**  
wireless information network

**Network configuration for WIN ethernet master**

Automatically obtain an IP address via DHCP  
If you select this option, please ensure that UDP broadcasts are permitted on your network. Your network administrator can provide further details.

Use the following static IP address:

IP-Address     .  .  .     e.g. 192.168.0.42

Subnet mask     .  .  .     e.g. 255.255.255.0

Default gateway     .  .  .

DNS-Server     .  .  .

Show advanced network configuration  
Please enter, for example, a DNS name for the WIN ethernet master if it is in a different sub-network or UDP broadcast is not possible.

 The configuration data can be obtained from your network administrator. Please also refer to the notes regarding the configuration in the user manual.  
[Download manual](#)

 **Cancel**  
Close

 **Next**  
Next step

There are three options available to connect to the network:

- Automatically obtain an IP address via DHCP
- Use a static IP address
- Advanced network configuration

- 
-  The **Advanced network configuration** must be used in the following cases:
- The WIN ethernet master and WERMA-WIN server service are in the same sub-network.
  - UDP broadcast is not allowed.
  - A static IP address should not be assigned.
- 

## 2.2.1 Automatically obtaining an IP address via DHCP

1. Select **Automatically obtain an IP address via DHCP** option.
2. Click on **Next**.
  - The configuration is transferred to the WIN ethernet master.
  - The configuration has been successfully completed.

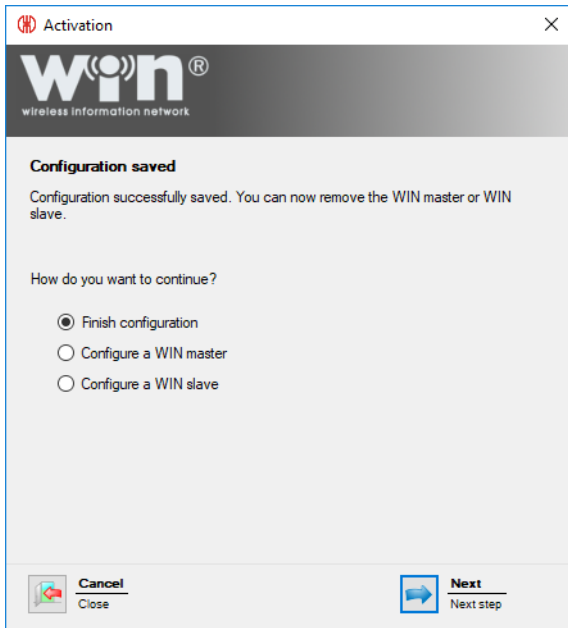

3. Now choose whether you wish to perform further configuration or exit configuration.
4. Click on **Next**.

## 2.2.2 Using a static IP address

1. Select **Use the following static IP address** option.

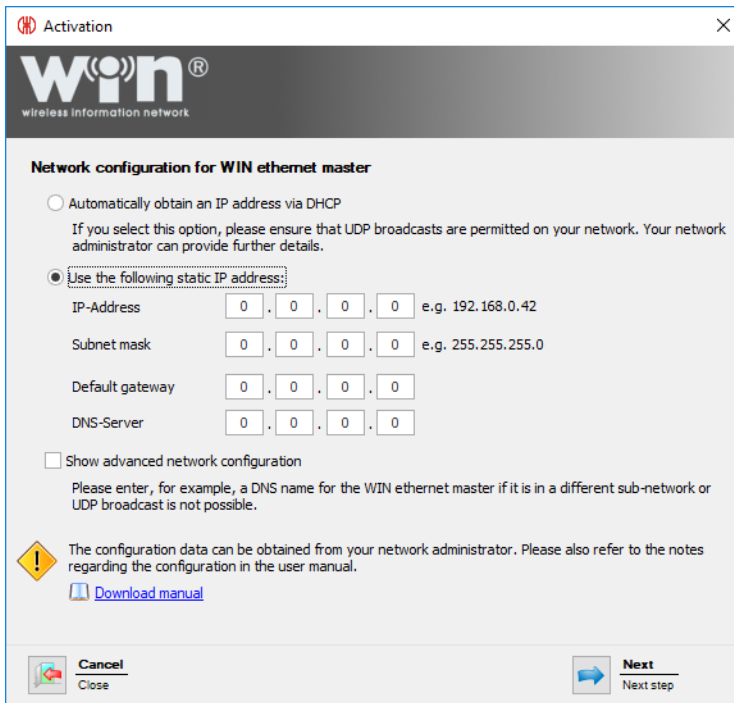

2. Enter the network data into the corresponding fields.

---

 Your network administrator will provide the requisite data.

---

**3. Click on **Next**.**

→ The configuration is transferred to the WIN ethernet master.

→ The configuration has been successfully completed.



**4. Now choose whether you wish to perform further configuration or exit configuration.**

**5. Click on **Next**.**

## 2.2.3 Advanced network configuration

**1. Select **Use the following static IP address** option.**

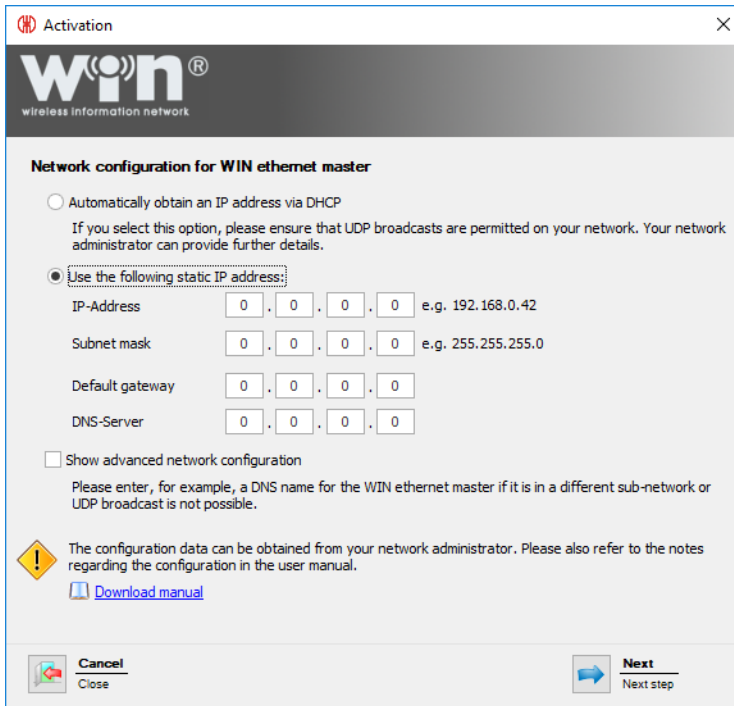

2. Enter the network data into the corresponding fields.

 Your network administrator will provide the requisite data.

3. Enable **Advanced network configuration**.

4. Click on **Next**.



5. Enter the IP address or DNS name of WIN ethernet master in the **IP / DNS name** field.

6. You may need to change the TCP port in the **TCP-Port** field.

**i** Your network administrator will provide the requisite data.

**7. Click on **Next**.**

→ The configuration has been successfully completed.

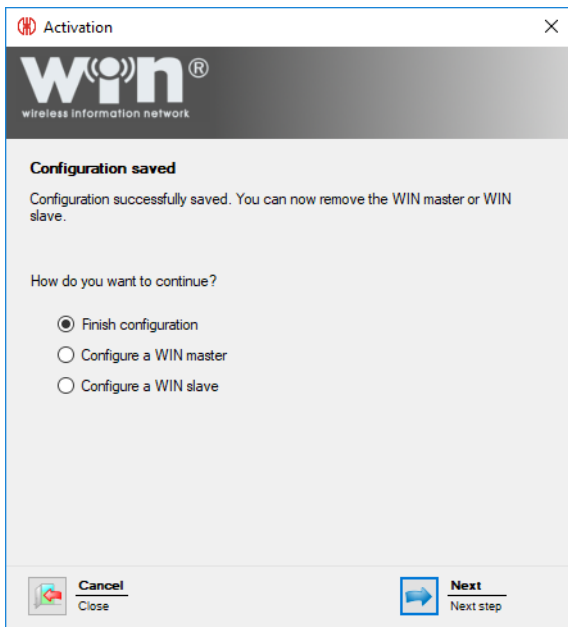

**8. Now choose whether you wish to perform further configuration or exit configuration.**

**9. Click on **Next**.**

## 2.3 WIN slave

**1. Start WERMA-WIN.**

**2. Use the USB cable to connect WIN slave to the PC.**

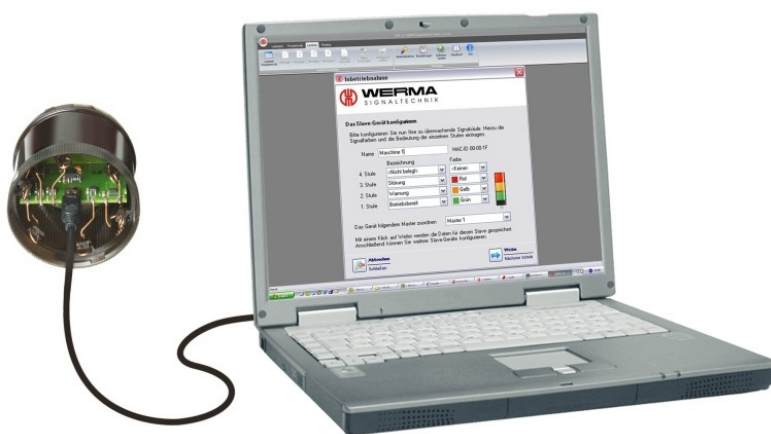

→ The **Commissioning** window appears.



3. Click on **Search** if WIN slave has not automatically been found.  
→ WERMA-WIN searches for the connected WIN slave.
4. Once WIN slave has been recognised, click on **Next**.

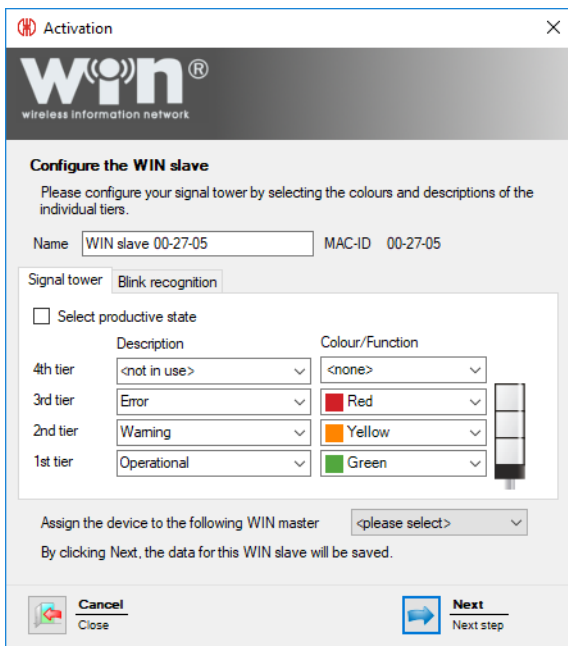

5. Enter the description of the WIN slave in the **Name** field.
6. Configure WIN slave in the **Signal tower** and **Blink recognition** tabs.
7. Assign WIN slave in the selection list **Assign the device to the following WIN master** to a WIN master.
8. Click on **Next**.  
→ The configuration has been successfully completed.



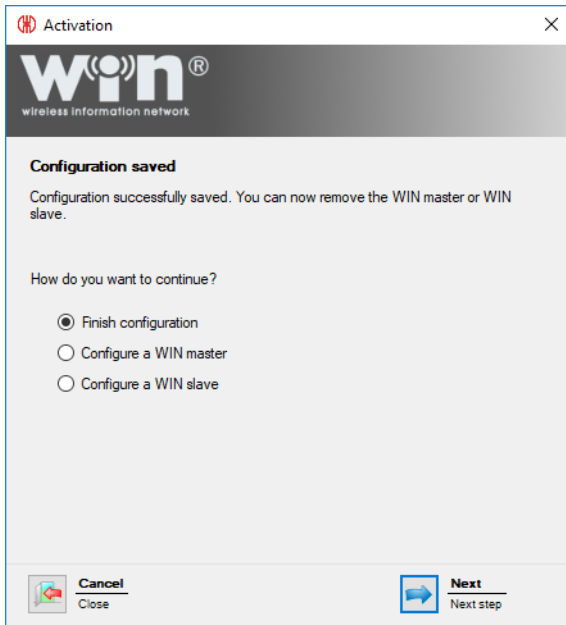

9. Now choose whether you wish to perform further configuration or stop configuration.
10. Click on **Next**.
11. Disconnect the USB connection from the WIN slave.  
→ The WIN slave is configured and can be fitted on the signal tower.

## 2.4 WIN slave performance

1. Start WERMA-WIN.
2. Use the USB cable to connect WIN slave performance to the PC.



→ The **Commissioning** window appears.



3. Click on **Search** if WIN slave performance has not automatically been found.  
→ WERMA-WIN searches for the connected WIN slave performance.
4. Once WIN slave performance has been recognised, click on **Next**.

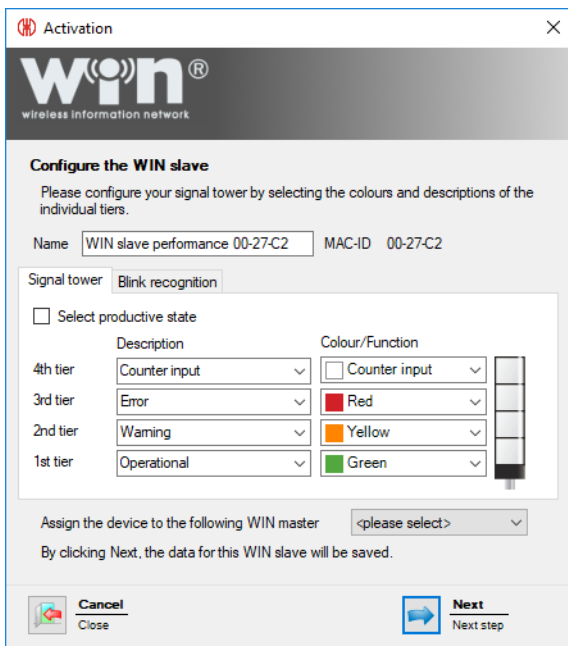

5. Enter the description of the WIN slave performance in the **Name** field.
6. Configure WIN slave performance in the **Signal tower** and **Blink recognition** tabs.
7. Assign WIN slave performance in the selection list **Assign the device to the following WIN master** to a WIN master.
8. Click on **Next**.  
→ The configuration has been successfully completed.

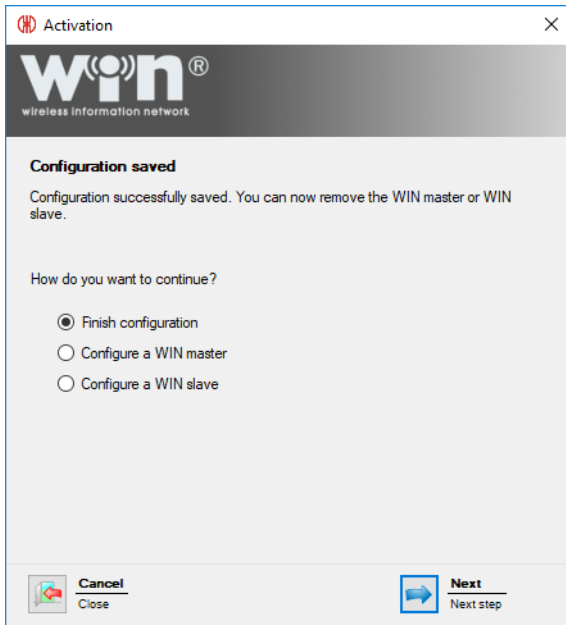

9. Now choose whether you wish to perform further configuration or stop configuration.
10. Click on **Next**.
11. Disconnect the USB connection from the WIN slave.  
→ The WIN slave performance is configured and can be fitted on the signal tower.

## 2.5 WIN slave control

1. Start WERMA-WIN.
2. Use the USB cable to connect WIN slave control to the PC.



→ The **Commissioning** window appears.



3. Click on **Search** if WIN slave control has not automatically been found.  
→ WERMA-WIN searches for the connected WIN slave control.
4. Once WIN slave control has been recognised, click on **Next**.

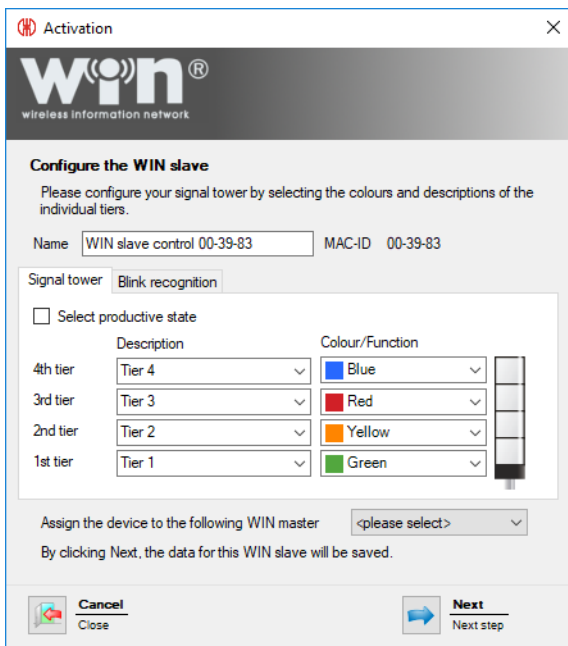

5. Enter the description of the WIN slave control in the **Name** field.
6. Configure WIN slave control in the **Signal tower** and **Blink recognition** tabs.
7. Assign WIN slave control in the selection list **Assign the device to the following WIN master** to a WIN master.
8. Click on **Next**.

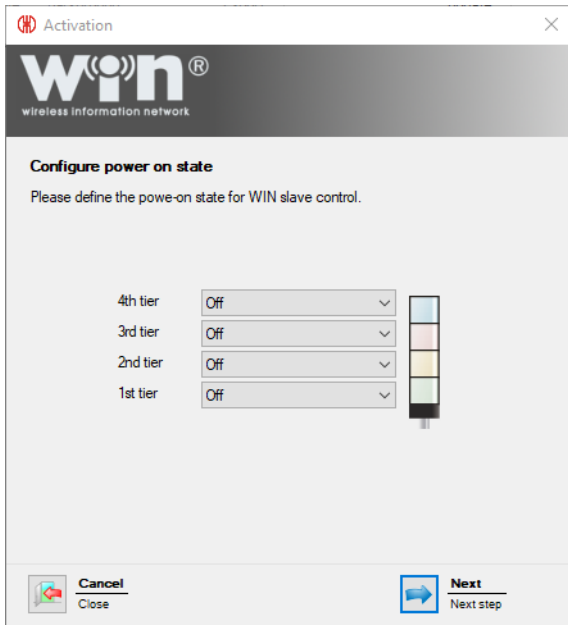

9. Configure the switching status of the individual tiers in the respective selection lists.

**i** The switching status is enabled as soon as power is supplied to the WIN slave control.

10. Click on **Next**.

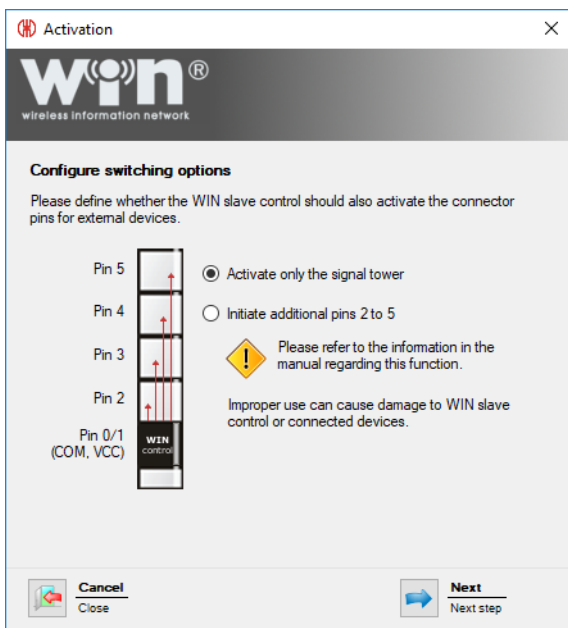

11. Select the switching condition of the WIN slave control.

12. Click on **Next**.

→ The configuration has been successfully completed.

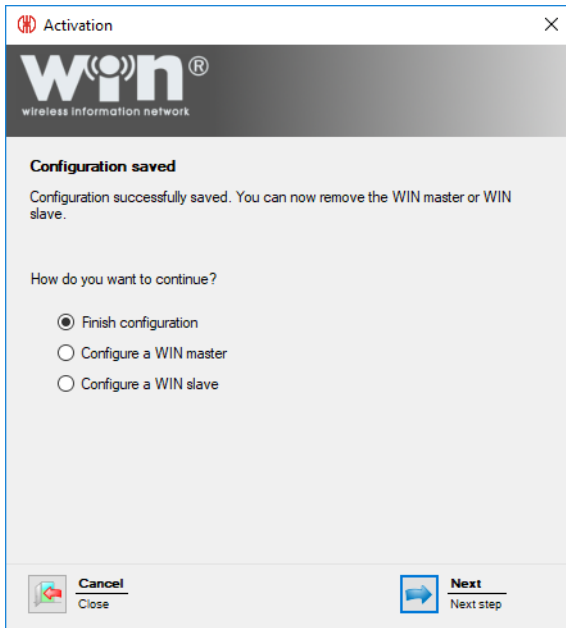

13. Now choose whether you wish to perform further configuration or stop configuration.
14. Click on **Next**.
15. Disconnect the USB connection from the WIN slave.  
→ The WIN slave control is configured and can be fitted on the signal tower.

## 2.6 Changing transmission channel

The transmission channel of the individual systems can be changed to enable the best possible radio connection when several WERMA-WIN systems are run in parallel. Four different transmission channels are available.

---

 WERMA recommends only operating one WIN master per transmission channel.

---

1. Click on **Activation** in the toolbar.  
→ The **Activation** window appears.

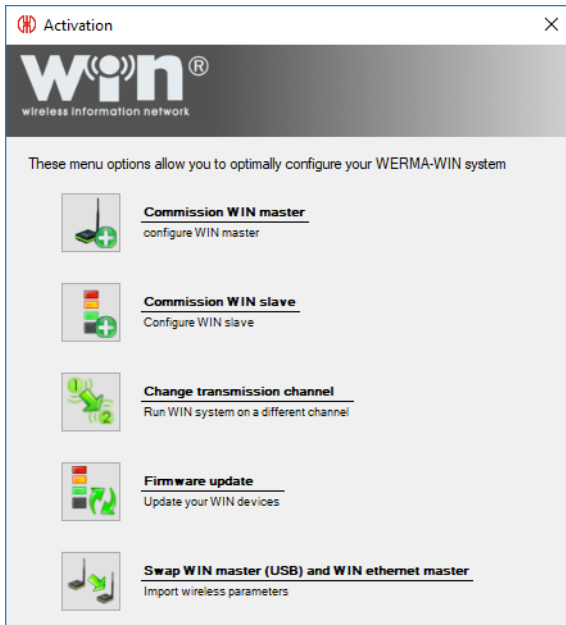

2. Click on **Change transmission channel**.  
→ The **Activation** window appears.



3. WIN master or start up WIN ethernet master again.
4. Select the preferred transmission channel in the **Channel** dropdown list during activation.

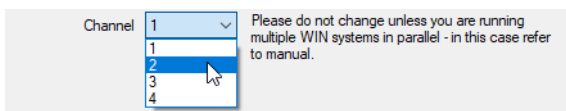



---

**i** WIN slave must be *reconfigured* if the WIN master transmission channel is changed after WIN slave has been configured.

---

## 2.7 Firmware update

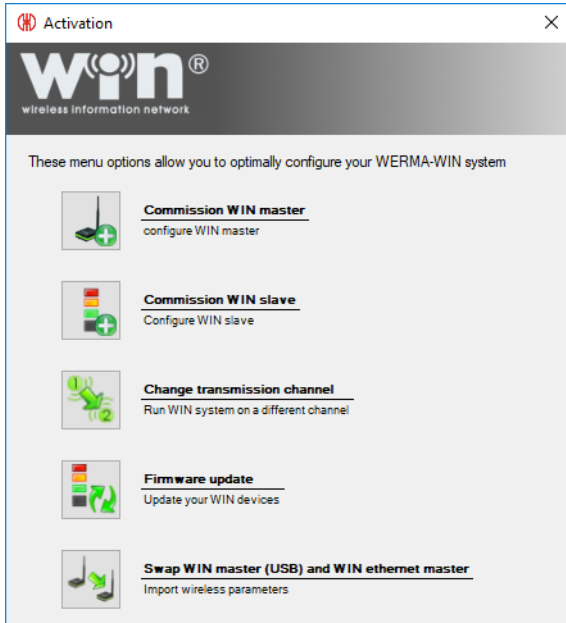
1. Click on **Activation** in the toolbar.  
→ The **Activation** window appears.



2. Click on **Firmware update**.

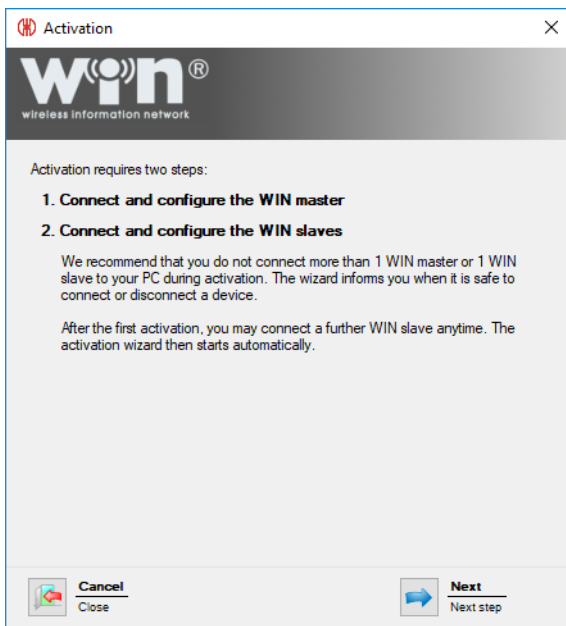

3. Read the information text and click on **Next**.  
→ The wizard for activation of a WERMA-WIN device appears.





4. WIN master or start up WIN ethernet master again.
5. During activation, confirm the firmware update message with **Yes**.  
→ The **Firmware update** window appears.

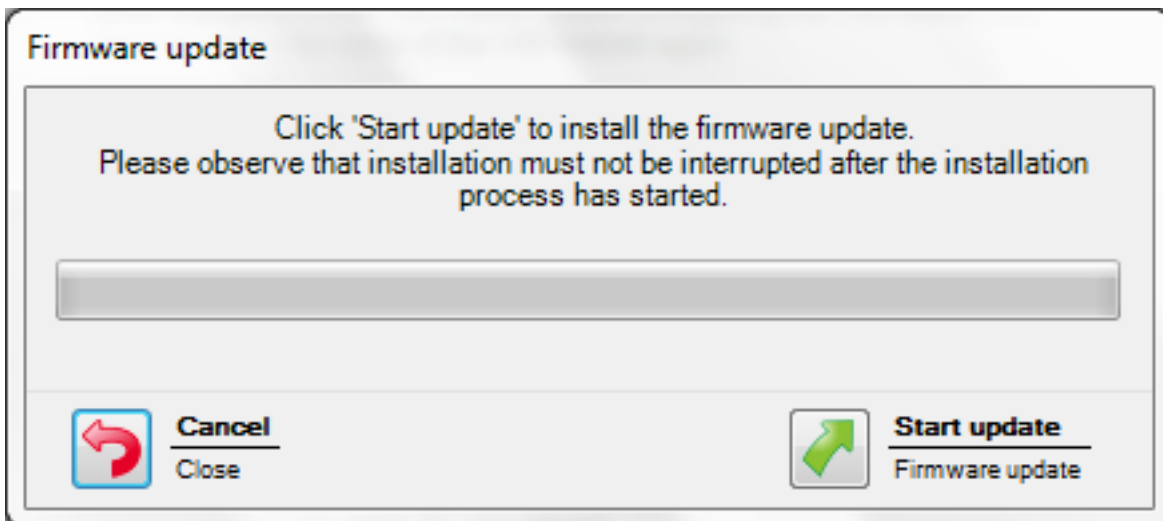

6. Click **Start update**.  
→ The firmware is updated.

## 2.8 Swapping WIN master and WIN ethernet master

A WIN master can be replaced by a WIN ethernet master. A wizard can be used to transmit all the WIN slaves assigned to the WIN master to the WIN ethernet master.

1. Click on **Activation** in the toolbar.  
→ The **Activation** window appears.

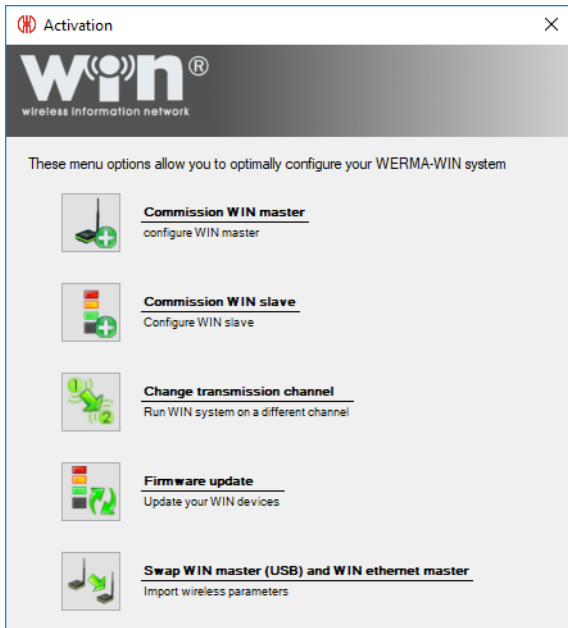

2. Click on **Swap WIN master (USB) and WIN ethernet master**.  
→ The **Activation** window appears.

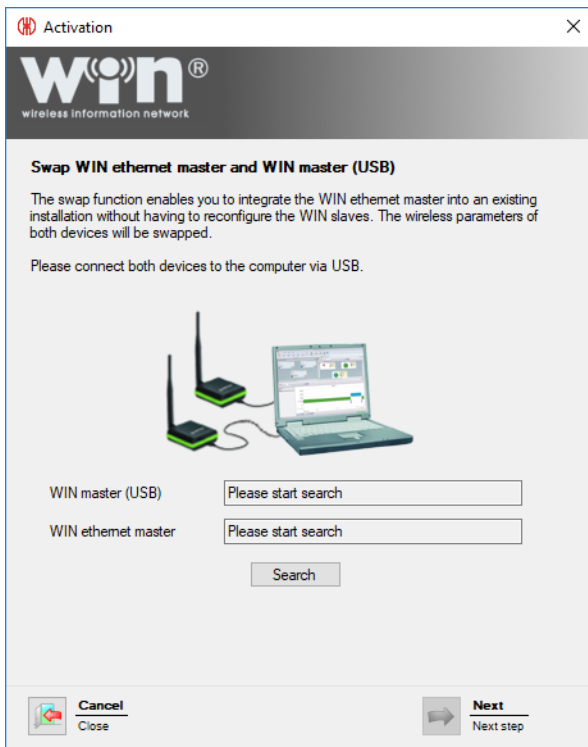

3. Connect WIN master and WIN ethernet master to the computer.
4. Click **Search**.  
→ WERMA-WIN searches for the connected WIN master and WIN ethernet master.



5. Once WIN master has been recognised, click on **Next**.  
→ WIN master and WIN ethernet master are swapped.

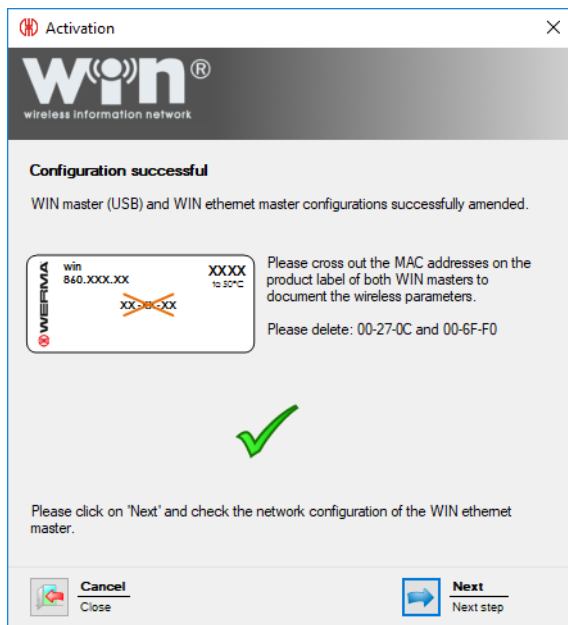

6. Once they have been successfully swapped, amend or strike through the MAC addresses printed on the type labels.
7. Click on **Next** to complete the swap and check the configuration of the WIN ethernet master.

**Activation**

**win**  
wireless information network

**Network configuration for WIN ethernet master**

Automatically obtain an IP address via DHCP  
If you select this option, please ensure that UDP broadcasts are permitted on your network. Your network administrator can provide further details.

Use the following static IP address:

IP-Address: 192 . 168 . 0 . 42 z.B. 192.168.0.42

Subnet mask: 255 . 255 . 255 . 0 z.B. 255.255.255.0

Default gateway: 0 . 0 . 0 . 0

DNS-Server: 0 . 0 . 0 . 0

Show advanced network configuration  
Please enter, for example, a DNS name for the WIN ethernet master if it is in a different sub-network or UDP broadcast is not possible.

The configuration data can be obtained from your network administrator. Please also refer to the notes regarding the configuration in the user manual.  
[Download manual](#)

**Cancel** **Next**  
Close Next step

8. Check the configuration of the WIN ethernet master and adapt if necessary.
9. Click on **Next** to save the configuration.  
→ The swap has been successfully completed.

**Activation**

**win**  
wireless information network

**Configuration saved**

Configuration successfully saved. You can now remove the WIN master or WIN slave.

How do you want to continue?

Finish configuration

Configure a WIN master

Configure a WIN slave

**Cancel** **Next**  
Close Next step

10. Now choose whether you wish to perform further configuration or exit configuration.
11. Click on **Next**.

## 3 Program functions

WERMA-WIN is subdivided into six main modules:

- Control station
- Productivity
- Runtime
- Job
- Control
- Routing

### 3.1 Control station

The statuses and job details of up to 50 machines, systems and workplaces are displayed in an overview in the **Control station** module. The overview shows which machine is running or has a fault. This enables reaction times and downtimes to be effectively shortened.

The job details show how far the jobs have progressed on the individual machines.

The position of a machine can be easily identified by the integration of a building plan into the Control station module.

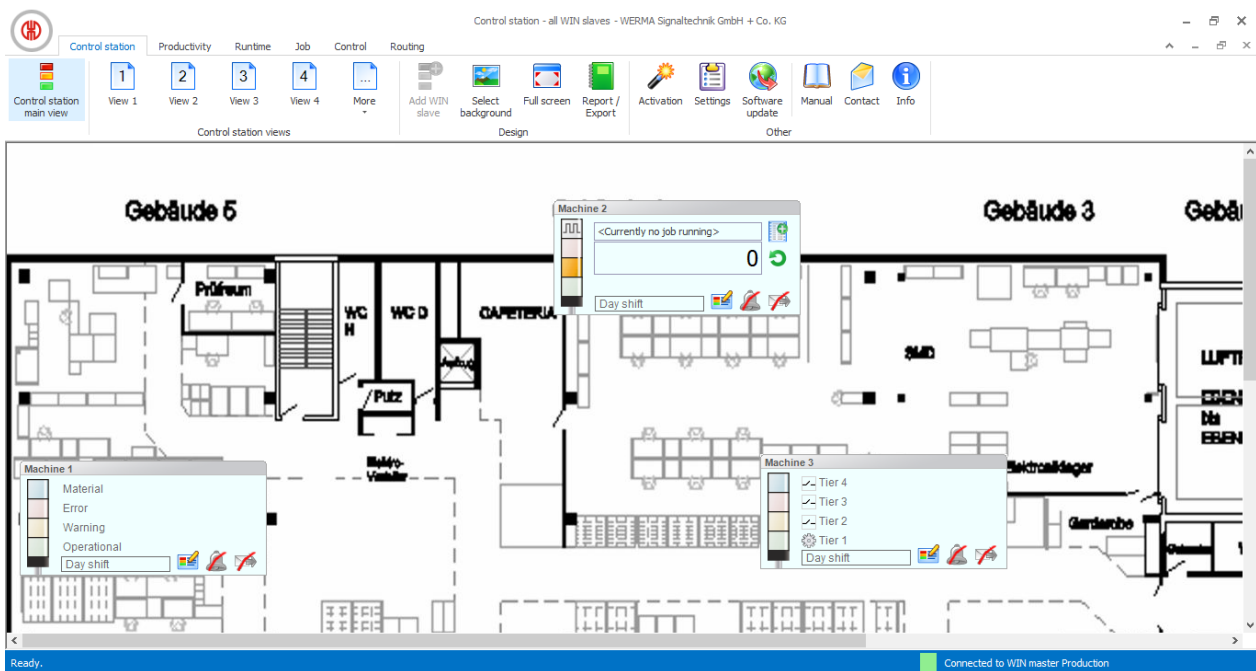





#### 3.1.1 Control station display

The control station display of the WIN slave shows the status of the respective signal tower or machine and enables the WIN slaves to be configured.

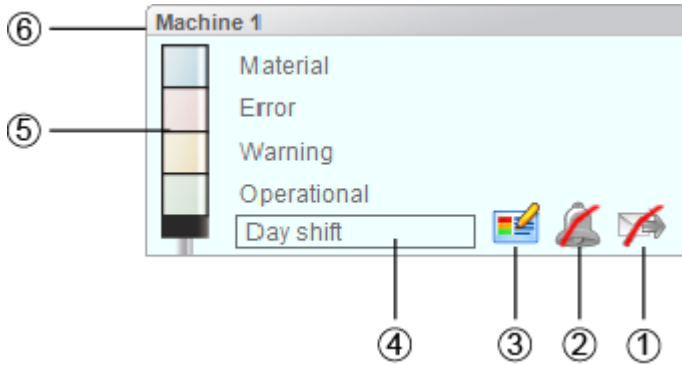
### 3.1.1.1 WIN slave

The control station display of the WIN slave includes the following information:





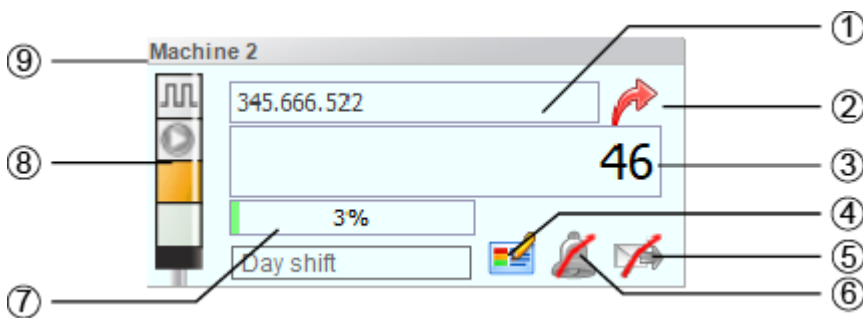

Item	Description
1	Enable, disable and set up status transmission  Status transmission is disabled.  Status transmission is enabled.
2	Enable, disable and set up status change message option  Status change message option is disabled.  Status change message option is enabled.
3	Edit WIN slave configuration
4	Current shift if a shift is assigned to the machine. <b>&lt;Pause&gt;</b> is displayed if there is a pause in the shift.
5	Representation of the statuses of tiers
6	Name of the WIN slave

### 3.1.1.2 WIN slave performance with running job

The control station display of a WIN slave performance with running job includes the following information:



Item	Description
1	Description of the running job
2	Call up job details
3	Current quantity
4	Edit WIN slave configuration
5	Enable, disable and set up status transmission  Status transmission is disabled.  Status transmission is enabled.
6	Enable, disable and set up status change message option  Status change message option is disabled.  Status changemessage option is enabled.
7	Job progression
8	Representation of the statuses of tiers
9	Name of the WIN slave

Additional job details appear as soon as the cursor hovers over the job progression (7).

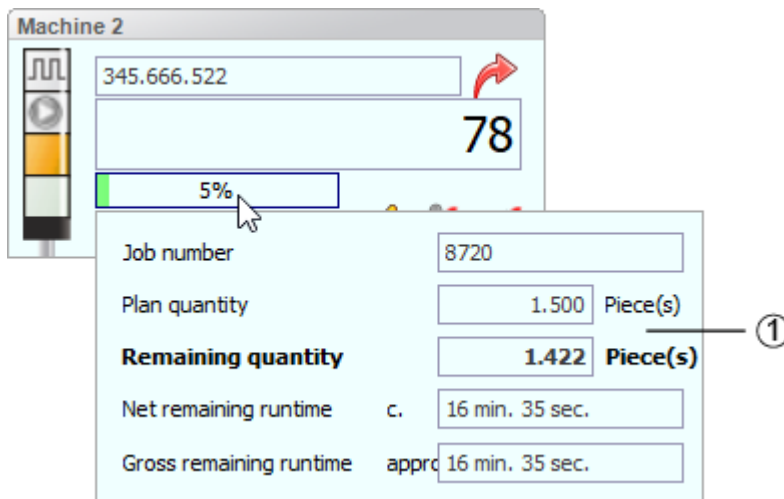

Item	Description
1	Hover function for additional job details <ul style="list-style-type: none"> <li>– <b>Job number:</b> Job number of the job</li> <li>– <b>Plan quantity:</b> Job quantity of the job</li> <li>– <b>Remaining quantity:</b> Quantity until the end of the job</li> <li>– <b>Net remaining runtime:</b> Time until the end of the job excluding pauses</li> <li>– <b>Gross remaining runtime:</b> Time until the end of the job including pauses</li> </ul>





As soon as the plan quantity has been reached with a job that does not stop automatically, a corresponding message appears in the additional Job details:

Plan quantity reached	
Job number	255.555.444.889
Plan quantity	10 Piece(s)
Remaining quantity	0 Piece(s)
Net remaining runtime	c. 0 sec.
Gross remaining runtime	approx 0 sec.

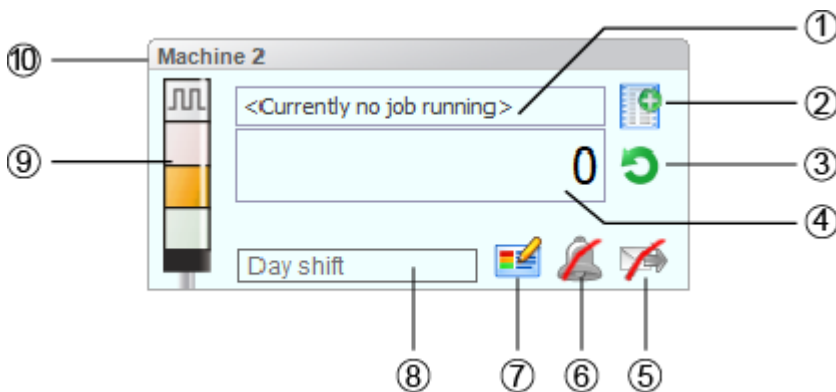
### 3.1.1.3 WIN slave performance without running job

The control station display of a WIN slave performance without running job includes the following information:









Item	Description
1	<b>No running job</b> information
2	Enter new job or series job
3	Reset counter value
4	Current quantity without plan specification
5	Enable, disable and set up status transmission  Status transmission is disabled.  Status transmission is enabled.
6	Enable, disable and set up status change message option  Status change message option is disabled.  Status change message option is enabled.
7	Edit WIN slave configuration
8	Current shift if a shift is assigned to the machine. <b>&lt;Pause&gt;</b> is displayed if there is a pause in the shift.
9	Representation of the statuses of tiers
10	Name of the WIN slave

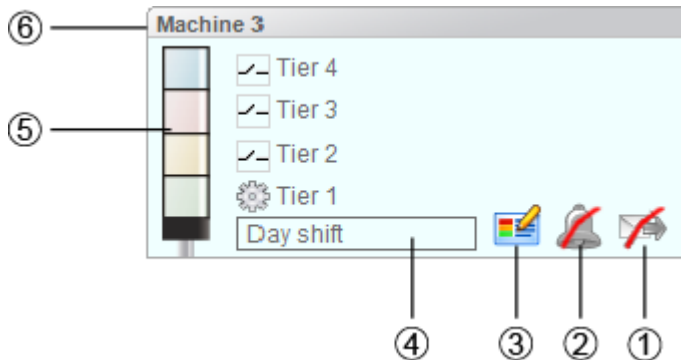

### 3.1.1.4 WIN slave control

The control station display of the WIN slave control includes the following information:



Item	Description
1	Enable, disable and set up status transmission  Status transmission is disabled.  Status transmission is enabled.
2	Enable, disable and set up status change message option  Status change message option is disabled.  Status change message option is enabled.
3	Edit WIN slave configuration
4	Current shift if a shift is assigned to the machine. <b>&lt;Pause&gt;</b> is displayed if there is a pause in the shift.
5	Representation of the statuses of tiers  Tier can be switched manually  Tier is controlled with a switching rule
6	Name of the WIN slave

## 3.1.2 Views

The **Control station main view** or a user-defined view can be used in the **Control station** module.

### 3.1.2.1 Control station main view

The **Control station main view** gives an overview of all WIN slaves that have been configured. The **Control station main view** can be provided with a background image.

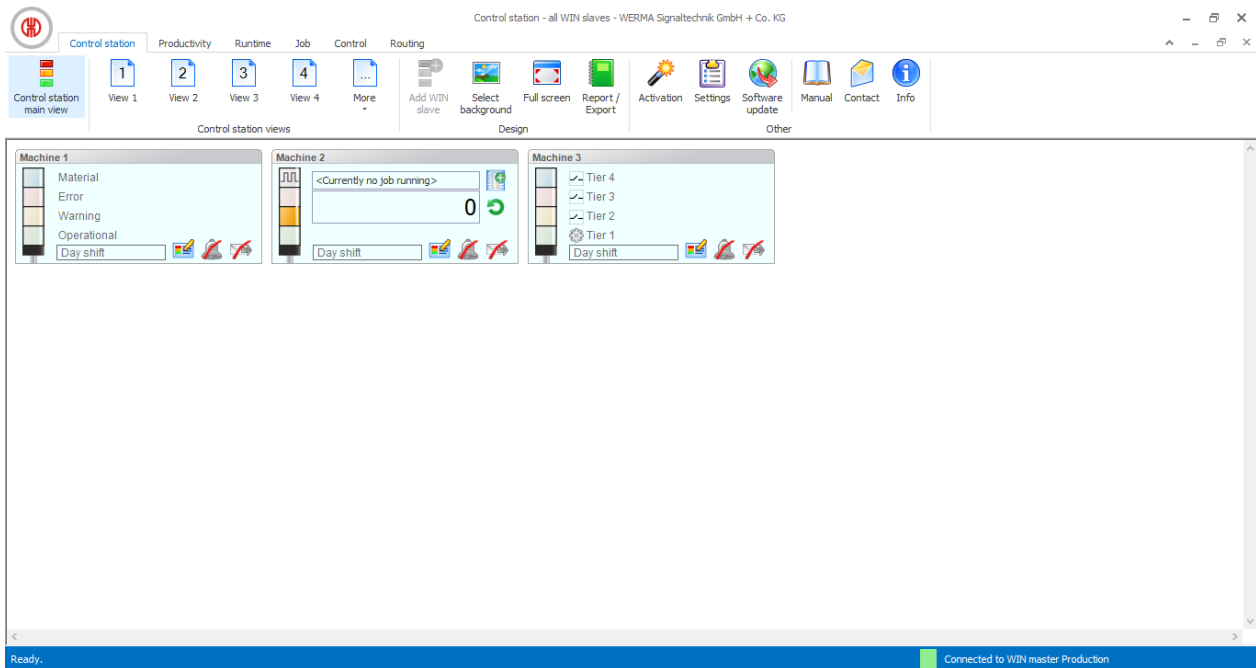

### 3.1.2.2 User-defined views

Additional user-defined views can be created in addition to the **Control station main view**.

The user-defined views can be named as required and be provided with a background image. Different WIN slaves can be displayed in every user-defined view.

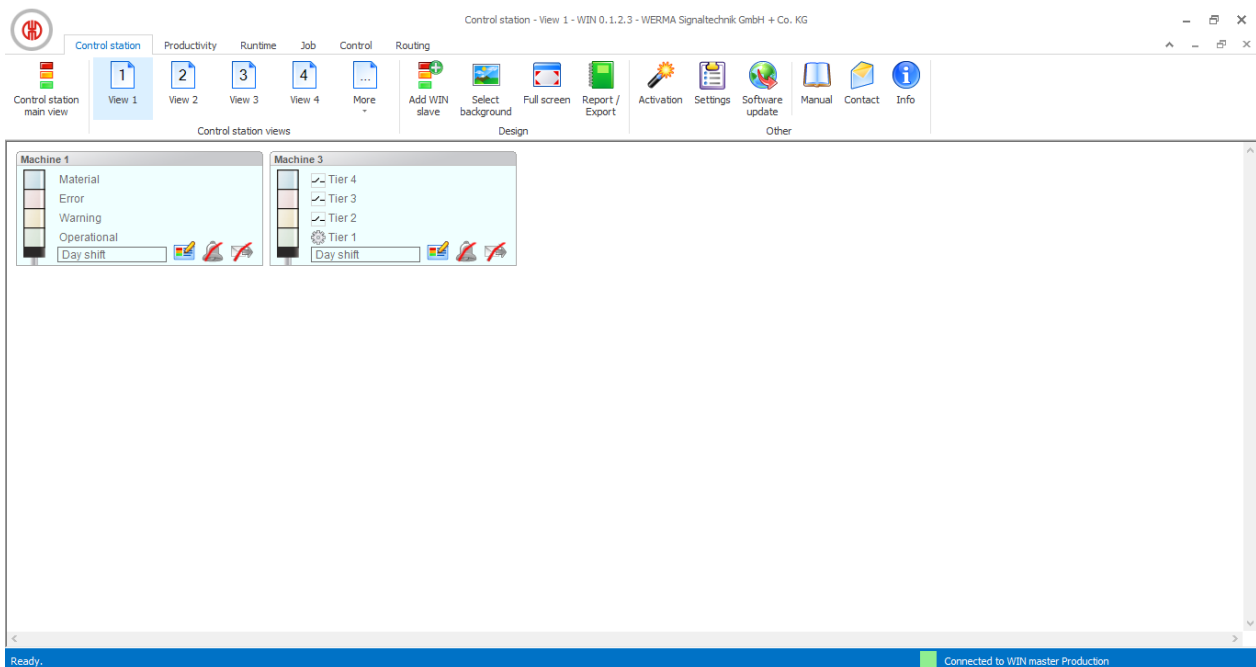

The user-defined views of the **Control station**, **Productivity** and **Runtime** modules are always identical. All view settings are applied.

### Naming a user-defined view

1. Click on **Settings** in the toolbar.  
→ The **Settings** window appears.
2. Select the **Views** tab.
3. Highlight the required view.
4. Click on **Edit**.  
→ The **Edit view** window appears.

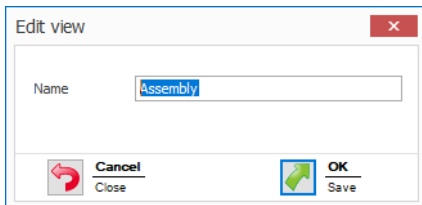

5. Enter the name of the view in the **Name** field.
6. Click on **OK**.  
→ The name of the view has been changed.
7. Click **OK** to apply the settings.

### Adding WIN slave to a view

1. Call up the required view.
2. Click on **Add WIN slave**.  
→ The **Select WIN slave** window appears.

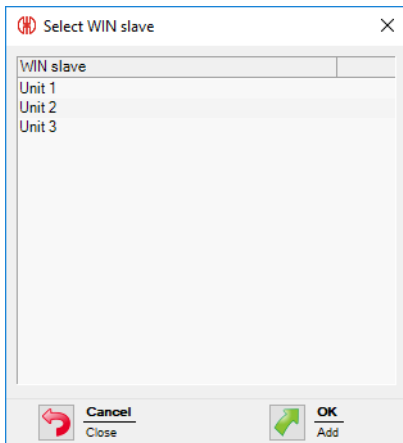

3. Highlight the required WIN slave.
4. Click on **OK**.  
→ The WIN slave has been added to the view.

### Deleting WIN slave from the view

1. Call up the required view.
2. Right-click on the WIN slave to be deleted.
3. Select **Remove** in the pop-up menu.

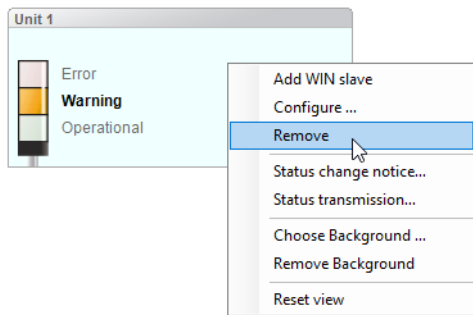

4. Confirm the prompt with **Yes**.  
→ The WIN slave has been deleted from the view.

### 3.1.2.3 Selecting the background image of a view

1. Call up the required view.
2. Click on **Select background**.  
→ The **Background image** window appears.

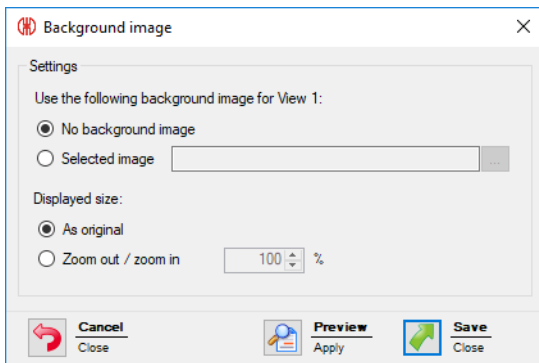

3. Select **Following** option.
4. Click on **Browse**  and open the required background image.



The background image needs to be saved on the local PC.

If more than one computer is accessing a WERMA-WIN database, then the background image must be saved on a network drive.

5. Select **As original** option to paste the background image in its original size.
6. Select **Zoom out / zoom in** option to paste the background imaged scaled.



Clicking on **Preview** allows a **preview** of the background image to be displayed.

7. Click on **Save** to paste the background image into the view.

### 3.1.2.4 Removing the background image

1. Call up the required view.
2. Click on **Select background**.  
→ The **Background image** window appears.

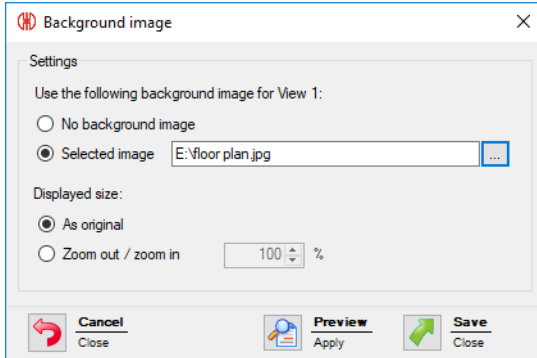

3. Select **No background image** option.
  4. Click on **Save** to paste the background image into the view.
- or -

1. Call up the required view.
2. Right-click in the view.
3. Select **Remove Background**.

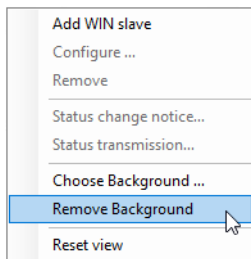

### 3.1.2.5 Repositioning a WIN slave

Every WIN slave can be repositioned anywhere in the view.

1. Left-click on the name of the WIN slave and hold down the mouse key.

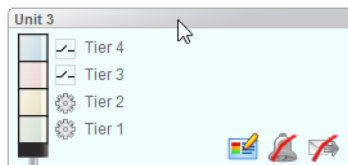

2. Drag the WIN slave to the desired position and release the mouse key.

### 3.1.2.6 Full-screen mode

Every view can be displayed in full screen and without the menu bar.

1. Call up the required view.
2. Click on **Full screen** in the menu bar.

To exit the full screen view:

1. Press **ESC**.

### 3.1.3 Configuration of the WERMA-WIN devices

Every WIN slave can be individually named and configured in accordance with the scope of its functions.

#### 3.1.3.1 Configuring WIN slave

1. Click on **Edit WIN slave**  in the control station display of the desired WIN slave.  
→ The **WIN slave configuration** window appears.

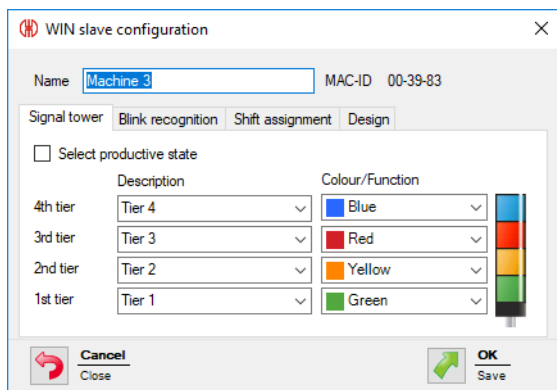

2. Configure the following settings:
  - Name of the WIN slave
  - Tiers and colours of the signal tower
  - Blink recognition
  - Shift assignment
  - Representation of the WIN slave
3. Once configuration has been completed, click on **OK** to save the settings.

#### Modifying the name

Every WIN slave can be individually named.

1. Enter the name of the WIN slave in the **Name** field.

Name

## Modifying the tiers and colours of the signal tower

The tiers and colours can be modified on the signal tower installed. A productive state can be defined, if required, for every tier and the statuses **Off** and **Connection error**. The productive statuses are evaluated in the **Productivity** module.

1. Select the **Signal tower** tab.

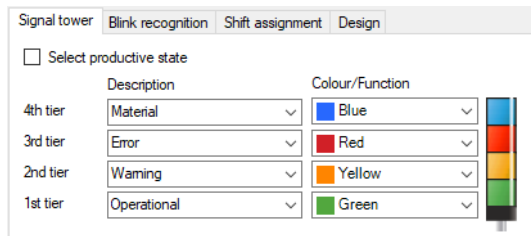

	Description	Colour/Function
4th tier	Material	Blue
3rd tier	Error	Red
2nd tier	Warning	Yellow
1st tier	Operational	Green

2. Define a **Description** and **Colour/Function** for the tiers of the WIN slave.



A user-defined description can be entered in the **Description** selection list. As soon as the configuration of the WIN slave has been saved, this user-defined description can be called up again using the selection list.

If a user-defined description is no longer used, it will not be displayed in the selection list any longer. Consequently, it is possible to delete misspelt or incorrectly created names (for example, mater-iaL, mter-iaL) from the selection list.

## Selecting productive states

To define the productive states of the tiers:

1. Select check box **Select productive state**.

2. The **Productive** column to select the productive states is shown.

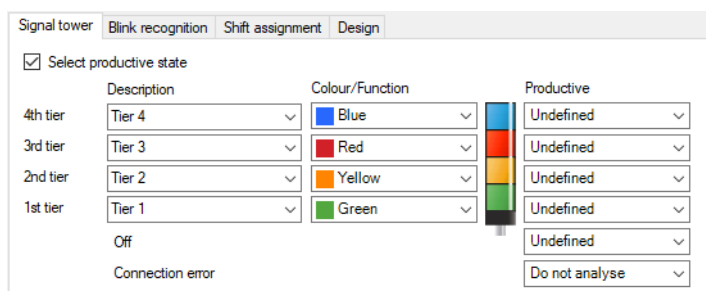

	Description	Colour/Function	Productive
4th tier	Tier 4	Blue	Undefined
3rd tier	Tier 3	Red	Undefined
2nd tier	Tier 2	Yellow	Undefined
1st tier	Tier 1	Green	Undefined
	Off		Undefined
	Connection error		Do not analyse

3. Define productive states for the tiers of the WIN slave.



The productive states are calculated in the evaluation based on the following priority:

- Non productive
- Productive
- Do not analyse
- Undefined

## Modifying blink recognition

If the signal tower installed has a blinking function, it can be evaluated using blink recognition. A productive status can be defined for every tier. The productive statuses are evaluated in the **Productivity** module.

- 
- i** Blink recognition detects blinking signals between 15 Hz and 0.8 Hz switching frequency generated by a machine or control (e.g. via the PLC).
- 

### 1. Select the **Blink recognition** tab.

	Blink recognition	Description
4th tier	<input checked="" type="checkbox"/>	Tier 4 blinking
3rd tier	<input checked="" type="checkbox"/>	Tier 3 blinking
2nd tier	<input checked="" type="checkbox"/>	Tier 2 blinking
1st tier	<input checked="" type="checkbox"/>	Tier 1 blinking

2. Enable or disable the **Blink recognition** checkbox to enable or disable blink recognition for the individual tiers of the WIN slave.
3. Defining a **Description** for the tiers of the WIN slave.
- 

- i** A user-defined description can be entered in the **Description** selection list. As soon as the configuration of the WIN slave has been saved, this description can be called up again using the selection list.
- 

## Selecting productive states

To define the productive states of the tiers:

### 1. Select check box **Select productive state**.

→ The **Productive** column to select the productive states is shown.

	Blink recognition	Description	Productive
4th tier	<input checked="" type="checkbox"/>	Tier 4 blinking	Undefined
3rd tier	<input checked="" type="checkbox"/>	Tier 3 blinking	Undefined
2nd tier	<input checked="" type="checkbox"/>	Tier 2 blinking	Undefined
1st tier	<input checked="" type="checkbox"/>	Tier 1 blinking	Undefined

### 2. Define productive states for the tiers of the WIN slave.

- 
- i** The productive states are calculated in the evaluation based on the following priority:
- Non productive
  - Productive
  - Do not analyse
-



 – Undefined

## Shift assignment

One or more shifts can be assigned to each WIN slave.

### Assigning shifts

1. Select the **Shift assignment** tab.

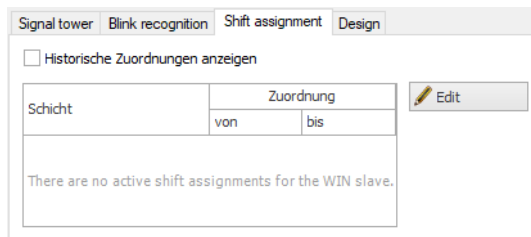

2. Click on **Edit**.

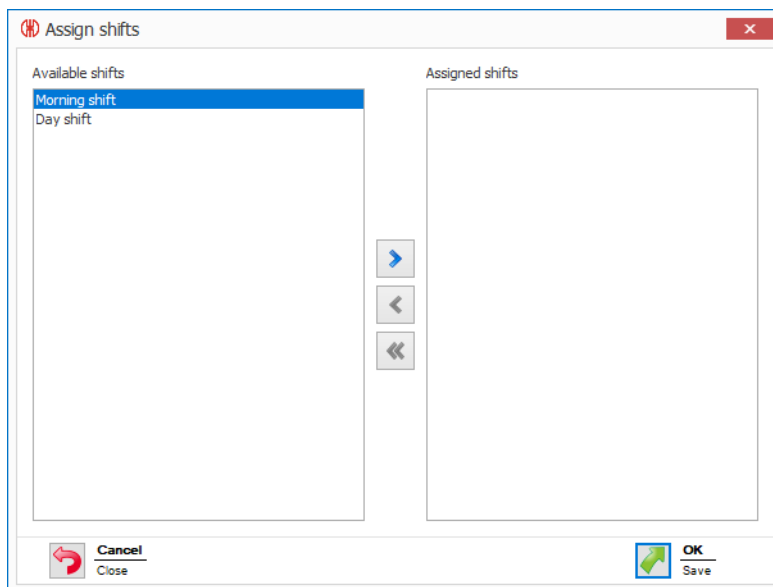

3. Double-click on the shift or shifts to be assigned to WIN slave in the **Available shifts** area.



Shifts can only be assigned if their time periods do not overlap.

If the time period of a shift in the **Available shifts** column overlaps with the time period of a shift already assigned in the **Assigned shifts** column, then the shift is disabled in the **Available shifts** column.

4. Click on **OK** to save the settings.

### Cancelling a shift assignment

1. Select the **Shift assignment** tab.

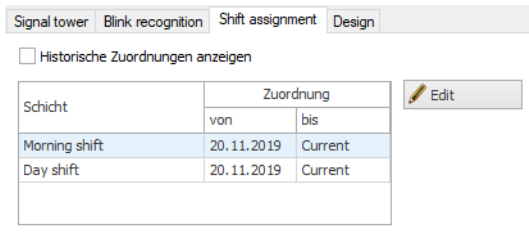

2. Click on **Edit**.

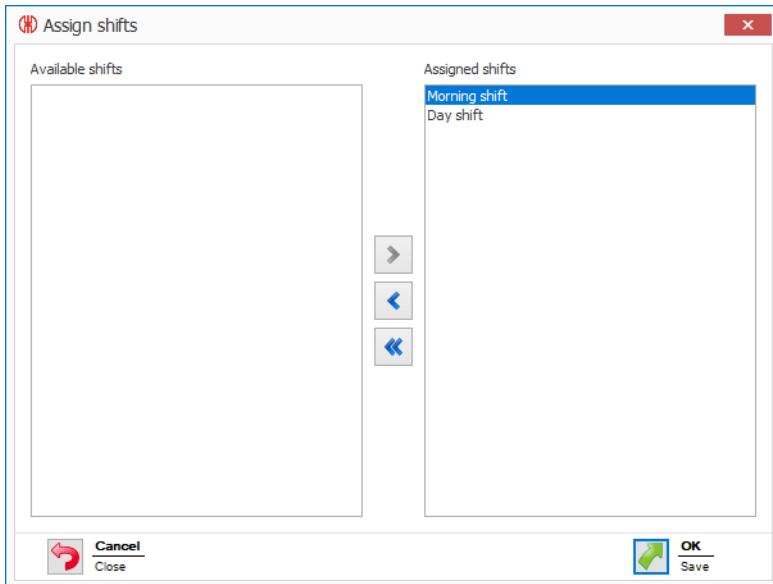

3. Double-click on the shift or shifts, the assignment of which is to be cancelled in the **Assigned shifts** area.
4. Click on **OK** to save the settings.

---

**i** Shifts whose assignment has been cancelled can be shown by enabling **Display historical assignments**.

---

## Modifying the control station display

The control station display of the WIN slave can be modified.

1. Select the **Design** tab.

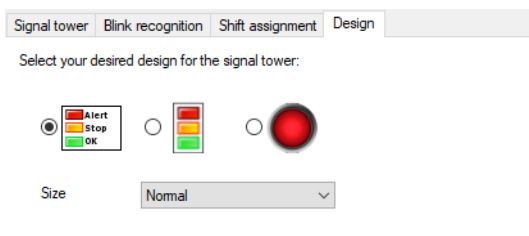

2. Select the display version of the WIN slave.
3. If necessary, select the size of the control station display in the **Size** selection list.

- i** If you have selected a display version with **Individual light** and the signal tower displays two states, the control station display automatically switches to the **Signal tower without text** display version.

### 3.1.3.2 Configuring WIN slave control

1. Click on **Edit WIN slave**  in the control station display of the desired WIN slave control.  
→ The **WIN slave configuration** window appears.

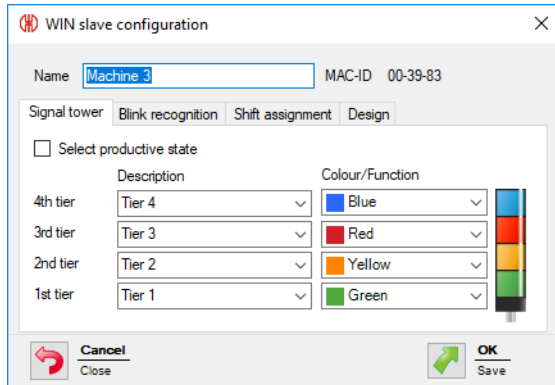

2. Configure the following settings:
  - Name of the WIN slave control
  - Tiers and colours of the signal tower
  - Blink recognition
  - Shift assignment
  - Control station display of the WIN slave control
3. Once configuration has been completed, click on **OK** to save the settings.

#### Modifying the name

Every WIN slave control can be individually named.

1. Enter the name of the WIN slave control in the **Name** field.

Name

#### Modifying the tiers and colours of the signal tower

The tiers and colours can be modified on the signal tower installed. A productive state can be defined, if required, for every tier and the statuses **Off** and **Connection error**. The productive statuses are evaluated in the **Productivity** module.

1. Select the **Signal tower** tab.

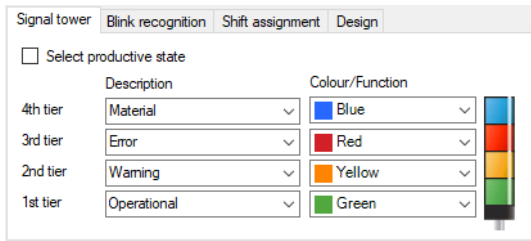

2. Define a **Description** and **Colour/Function** for the tiers of the WIN slave control.



A user-defined description can be entered in the **Description** selection list. As soon as the configuration of the WIN slave control has been saved, this user-defined description can be called up again using the selection list.

If a user-defined description is no longer used, it will not be displayed in the selection list any longer. Consequently, it is possible to delete misspelt or incorrectly created names (for example, material, mterial) from the selection list.

### Selecting productive states

To define the productive states of the tiers:

1. Select check box **Select productive state**.
2. The **Productive** column to select the productive states is shown.

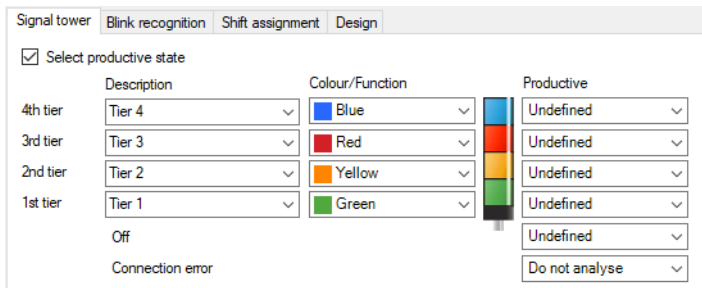

3. Define productive states for the tiers of the WIN slave control.



The productive states are calculated in the evaluation based on the following priority:

- Non productive
- Productive
- Do not analyse
- Undefined

### Modifying blink recognition

Blink recognition is enabled by default for all tiers with the WIN slave control. Blink recognition can be used with the **manual control** function or with the definition of a *switching rule*.

A productive status can be defined for every tier. The productive states are evaluated in the **Productivity** module.

- i** The blink signal is transmitted to the signal tower and the terminals at a switching frequency of 1 Hz.

**1. Select the **Blink recognition** tab.**

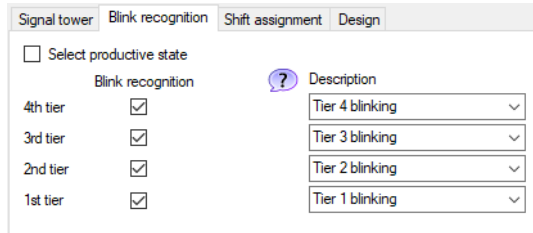

- 2. Enable or disable the **Blink recognition** checkbox to enable or disable blink recognition for the individual tiers of the WIN slave control.**

**3. Defining a **Description** for the tiers of the WIN slave control.**

- i** A user-defined description can be entered in the **Description** selection list. As soon as the configuration of the WIN slave control has been saved, this description can be called up again using the selection list.

### Selecting productive states

To define the productive states of the tiers:

**1. Select check box **Select productive state**.**

→ The **Productive** column to select the productive states is shown.

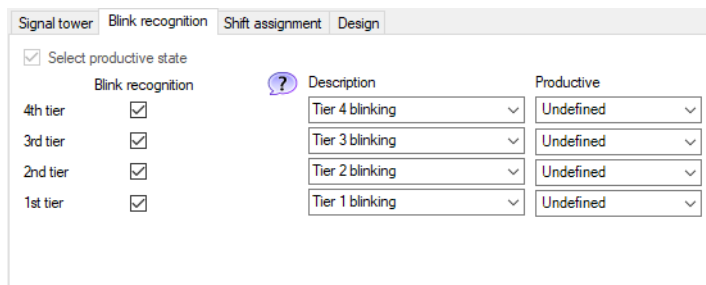

**2. Select productive states for the tiers of the WIN slave control.**

- i** The productive states are calculated in the evaluation based on the following priority:
- Non productive
  - Productive
  - Do not analyse
  - Undefined

### Shift assignment

One or more shifts can be assigned to each WIN slave control.

## Assigning shifts

1. Select the **Shift assignment** tab.

Schicht	Zuordnung	
	von	bis
There are no active shift assignments for the WIN slave.		

2. Click on **Edit**.

Available shifts	Assigned shifts
Morning shift	
Day shift	

3. Double-click on the shift or shifts to be assigned to WIN slave control in the **Available shifts** area.



Shifts can only be assigned if their time periods do not overlap.

If the time period of a shift in the **Available shifts** column overlaps with the time period of a shift already assigned in the **Assigned shifts** column, then the shift is disabled in the **Available shifts** column.

4. Click on **OK** to save the settings.

## Cancelling a shift assignment

1. Select the **Shift assignment** tab.

Schicht	Zuordnung	
	von	bis
Morning shift	20.11.2019	Current
Day shift	20.11.2019	Current

2. Click on **Edit**.

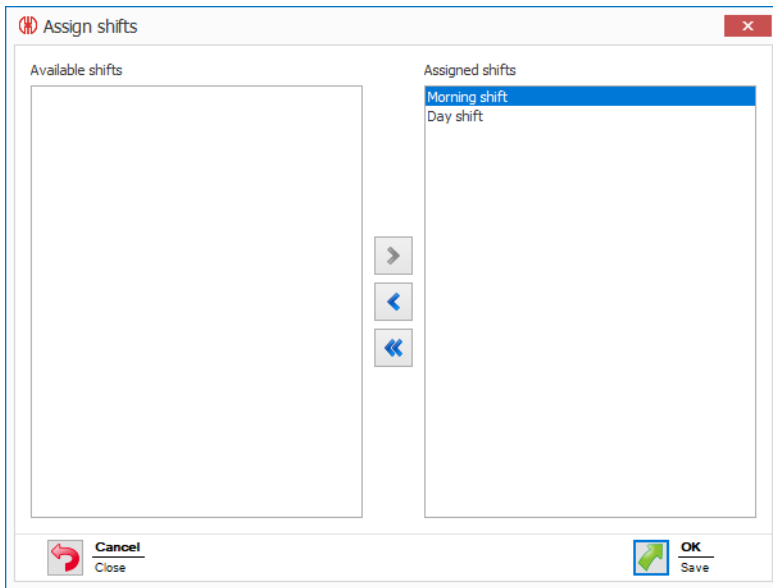

3. Double-click on the shift or shifts, the assignment of which is to be cancelled in the **Assigned shifts** area.

4. Click on **OK** to save the settings.

---

**i** Shifts whose assignment has been cancelled can be shown by enabling **Display historical assignments**.

---

## Modifying the control station display

The control station display of the WIN slave control can be modified.

---

**i** The **manual control** function is only possible in the **Signal tower with text** display version.

---

1. Select the **Design** tab.

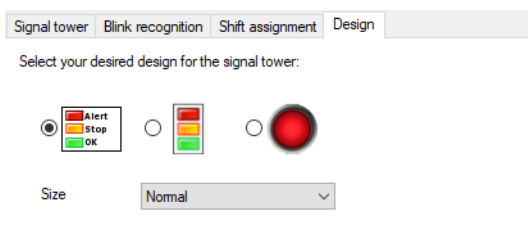

2. Select the display version of the WIN slave control.

3. If necessary, select the size of the control station display in the **Size** selection list.

---

**i** If you have selected a display version with **Individual light** and the signal tower displays

---



two states, the control station display automatically switches to the **Signal tower without text** display version.

### 3.1.3.3 Configuring WIN slave performance

1. Click on **Edit WIN slave**  in the control station display of the desired WIN slave performance.  
→ The **WIN slave configuration** window appears.

	Description	Colour/Function	Productive
4th tier	Counter input	Counter input	Undefined
3rd tier	Job input	Job input	Undefined
2nd tier	Warning	Yellow	Productive
1st tier	Operational	Green	Productive
Off	Off		Non productive
Connection error	Connection error		Do not analyse

2. Configure the following settings:
  - Name of the WIN slave performance
  - Tiers and colours of the signal tower
  - Blink recognition
  - Shift assignment
  - Control station display of the WIN slave performance
3. Once configuration has been completed, click on **OK** to save the settings.

#### Modifying the name

Every WIN slave performance can be individually named.

1. Enter the name of the WIN slave performance in the **Name** field.

Name

#### Modifying the tiers and colours of the signal tower

The tiers and colours can be modified on the signal tower installed. A productive state can be defined, if required, for every tier and the statuses **Off** and **Connection error**. The productive statuses are evaluated in the **Productivity** module.

1. Select the **Signal tower** tab.



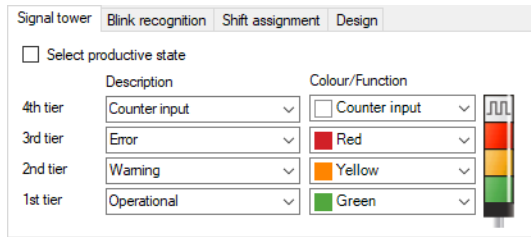

## 2. Define a **Description** and **Colour/Function** for the tiers of the WIN slave.

- i** A user-defined description can be entered in the **Description** selection list. As soon as the configuration of the WIN slave has been saved, this user-defined description can be called up again using the selection list.

If a user-defined description is no longer used, it will not be displayed in the selection list any longer. Consequently, it is possible to delete misspelt or incorrectly created names (for example, `material`, `mterial`) from the selection list.

- i** The **Counter input** and **Job input** functions can each only be defined for one tier.

- i** The maximum counter frequency of the counter input is 10 Hz ( $> 50 \text{ ms } 24 \text{ V} - > 50 \text{ ms } 0 \text{ V}$ ).

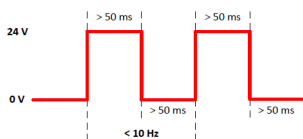

- i** The **Counter input** function was assigned to a tier during activation of the WIN slave performance. If the **Counter input** function is to be assigned to another tier, you must connect the WIN slave performance to the PC using the USB cable to transfer the modified configuration.

- i** The pulse at the tier configured for the **Job input** function must be applied for at least five seconds. The first pulse starts the job and the second pulse completes the job. If you have already created another job as **active waiting**, it can be started with a further pulse.

The pulse can also be applied for the whole duration of the job. Then the pulse must be inactive for at least five seconds so that a further pulse ends the job.



### Selecting productive states

To define the productive states of the tiers:

1. Select check box **Select productive state**.

2. The **Productive** column to select the productive states is shown.

	Description	Colour/Function	Productive
4th tier	Counter input	Counter input	Undefined
3rd tier	Error	Red	Undefined
2nd tier	Warning	Yellow	Undefined
1st tier	Operational	Green	Undefined
	Off		Undefined
	Connection error		Do not analyse

3. Define productive states for the tiers of the WIN slave performance.

- i** The productive states are calculated in the evaluation based on the following priority:
- Non productive
  - Productive
  - Do not analyse
  - Undefined

## Modifying blink recognition

If the signal tower installed has a blinking function, it can be evaluated using blink recognition. A productive status can be defined for every tier. The productive statuses are evaluated in the **Productivity** module.

- i** Blink recognition detects blinking signals between 15 Hz and 0.8 Hz switching frequency generated by a machine or control (e.g. via the PLC).

1. Select the **Blink recognition** tab.

	Blink recognition	Description
4th tier	<input checked="" type="checkbox"/>	Tier 4 blinking
3rd tier	<input checked="" type="checkbox"/>	Tier 3 blinking
2nd tier	<input checked="" type="checkbox"/>	Tier 2 blinking
1st tier	<input checked="" type="checkbox"/>	Tier 1 blinking

2. Enable or disable the **Blink recognition** checkbox to enable or disable blink recognition for the individual tiers of the WIN slave performance.

3. Defining a **Description** for the tiers of the WIN slave performance.

- i** A user-defined description can be entered in the **Description** selection list. As soon as the configuration of the WIN slave performance has been saved, this description can be called up again using the selection list.

## Selecting productive states

To define the productive states of the tiers:

### 1. Select check box **Select productive state**.

→ The **Productive** column to select the productive states is shown.

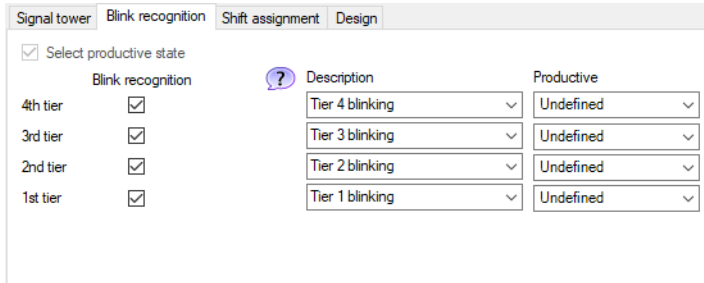

	Blink recognition	Description	Productive
4th tier	<input checked="" type="checkbox"/>	Tier 4 blinking	Undefined
3rd tier	<input checked="" type="checkbox"/>	Tier 3 blinking	Undefined
2nd tier	<input checked="" type="checkbox"/>	Tier 2 blinking	Undefined
1st tier	<input checked="" type="checkbox"/>	Tier 1 blinking	Undefined

### 2. Define productive states for the tiers of the WIN slave performance.



The productive states are calculated in the evaluation based on the following priority:

- Non productive
- Productive
- Do not analyse
- Undefined

## Shift assignment

One or more shifts can be assigned to each WIN slave performance.

### Assigning shifts

#### 1. Select the **Shift assignment** tab.

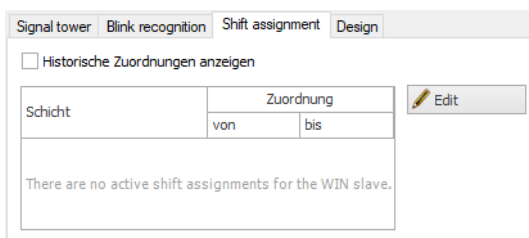

Schicht	Zuordnung		Edit
	von	bis	
There are no active shift assignments for the WIN slave.			

#### 2. Click on **Edit**.

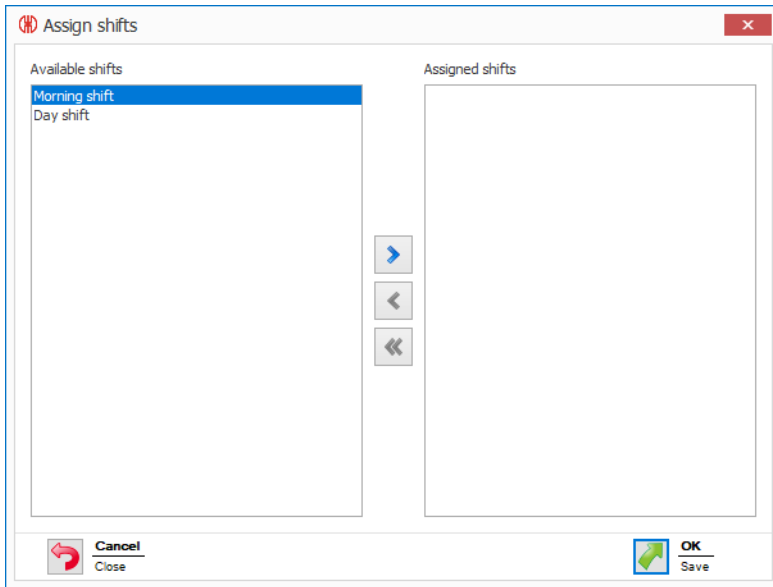

3. Double-click on the shift or shifts to be assigned to WIN slave performance in the **Available shifts** area.



Shifts can only be assigned if their time periods do not overlap.

If the time period of a shift in the **Available shifts** column overlaps with the time period of a shift already assigned in the **Assigned shifts** column, then the shift is disabled in the **Available shifts** column.

4. Click on **OK** to save the settings.

### Cancelling a shift assignment

1. Select the **Shift assignment** tab.

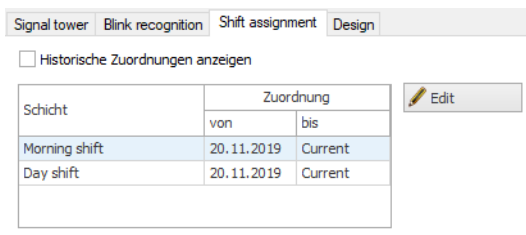

2. Click on **Edit**.

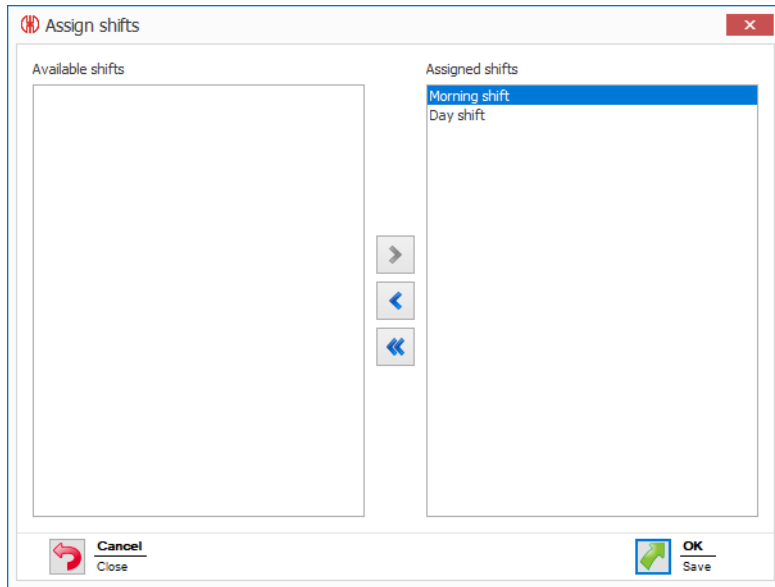

3. Double-click on the shift or shifts, the assignment of which is to be cancelled in the **Assigned shifts** area.
4. Click on **OK** to save the settings.

 Shifts whose assignment has been cancelled can be shown by enabling **Display historical assignments**.

## Modifying the control station display

The control station display of the WIN slave performance can be modified.

1. Select the **Design** tab.

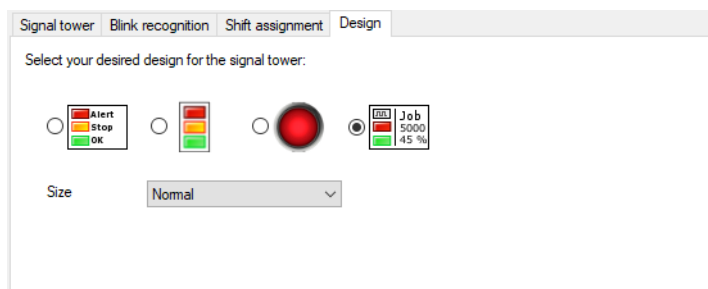

2. Select the display version of the WIN slave performance.
3. If necessary, select the size of the control station display in the **Size** selection list.

 If you have selected a display version with **Individual light** and the signal tower displays two states, the control station display automatically switches to the **Signal tower without text** display version.

### 3.1.4 Resetting the quantity counter

Quantities can be counted without or with job with every WIN slave performance. The counter can only be reset when counting without a job.

1. In the control station display of the WIN slave performance, click on **Reset counter** .
2. Confirm the prompt with **Yes** to reset the quantity counter.  
→ The counter has been reset.

### 3.1.5 Manual control

Every WIN slave control can be switched or controlled manually or via a *Switching rule*.

1. Click on **Switch**  beside the tier to be switched.  
→ The menu to select the switching status appears.



2. Select the switching status of the tier.  
→ The tier of the signal tower is switched and displayed in the control station display.



---

 Tiers that can be controlled with a switching rule () cannot be manually controlled.

---

 The **Blinking** status is only available if the *Blink recognition* of the tier is enabled.

---

 The **Switch**  symbol can flicker during transmission of the switching status. As soon as the transmission of the WIN slave control has been confirmed, the symbol changes to a permanent representation.

---

### 3.1.6 Status change message

If the status change message of a WIN slave is enabled, a pop-up window appears when the status of the signal tower is changed. This allows you to minimise the WERMA-WIN program window without neglecting to monitor the machines.

It is possible to define for each tier whether and when a pop-up window appears (e.g. Tier on, Tier off, Connection error).

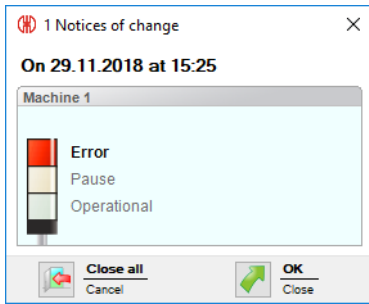

1. Click on **Status change message option deactivated**  in the control station display of the WIN slave.  
→ The **Status Change Message** window appears.

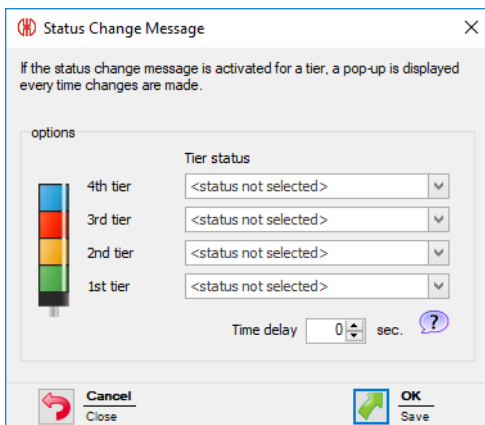

2. Define for each tier in the **Tier status** selection menu whether and at what status a pop-up window is to be displayed.

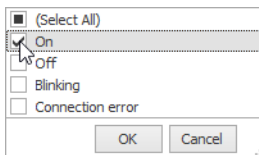

- 
- i** A status change message can be generated for a tier with the function **Counter input** with the WIN slave performance.
- 

3. Click on **OK** to save the settings.
4. Define the **Time delay**.

- 
- i** The pop-up window only appears when the new status is unchanged during the defined **Time delay**. No pop-up window appears if the status has changed again within the **Time delay**.
- 

5. Click on **OK** to save the settings.  
→ The status change message has been enabled.

- The **Status change message option activated** symbol  appears in the control station display of WIN slave.

 An individual sound can be defined under *Settings* for the status change message.

### 3.1.7 Status transmission

If the status transmission of a WIN slave is active, an e-mail is sent to one or more recipients when the status of the signal tower changes. This enables WERMA-WIN to be run on an unattended PC or server without neglecting to monitor the machines.

It is possible to define for each tier whether and when a pop-up window appears (e.g. Tier on, Tier off, Connection error).

#### 3.1.7.1 WIN slave and WIN slave control

- In the control station display of the WIN slave or WIN slave control, click on **Status transmission deactivated**  .  
→ The **Status transmission** window appears.

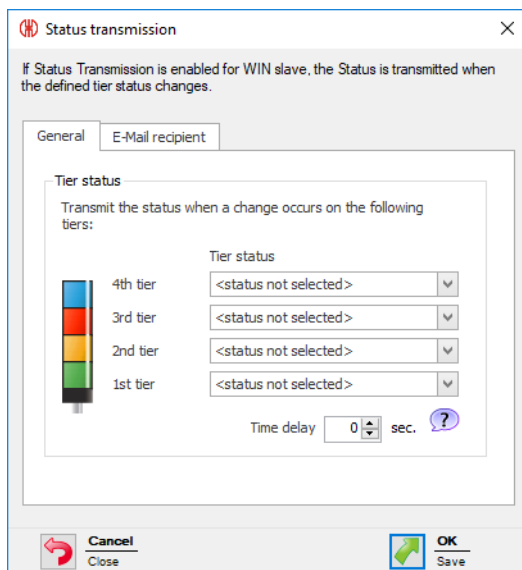

- Select the **General** tab.
- Define for each tier in the **Tier status** selection menu whether and at what status a pop-up window is to be displayed.

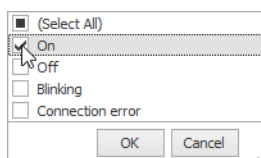



4. Define the **Time delay**.

-  The e-mail is only sent if the new status is unchanged during the defined **Time delay**. No email is sent if the status has changed again within the **Time delay**.

5. Select the **E-mail recipient** tab.

6. Select the e-mail recipient.

Option	Description
<b>As specified in Settings</b>	Send an e-mail to the recipient specified under <i>Settings</i> .
<b>Selected recipients</b>	Send an e-mail to the specified recipient(s). Multiple recipients are separated by a semi-colon (;).
<b>Define a recipient per tier</b>	Send an e-mail to the specified recipient(s) per tier. Multiple recipients are separated by a semi-colon (;).

7. Click on **OK** to save the settings.  
 → Status transmission has been enabled.  
 → In the control station display of the WIN slave or WIN slave control, the **Status transmission activated**  symbol appears.

### 3.1.7.2 WIN slave performance

1. In the control station display of the WIN slave performance, click on **Status transmission deactivated** .  
 → The **Status transmission** window appears.

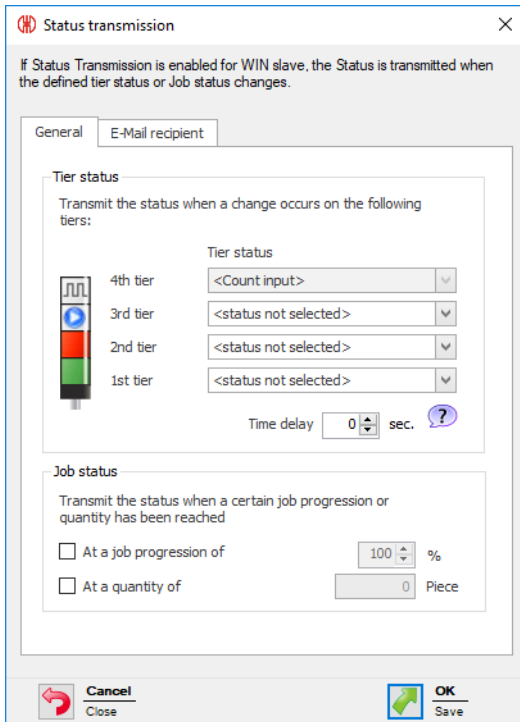

2. Select the **General** tab.
3. Define for each tier in the **Tier status** selection menu whether and at what status a pop-up window is to be displayed.

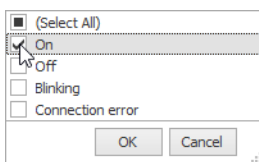

4. Define the **Time delay**.

**i** The e-mail is only sent if the new status is unchanged during the defined **Time delay**. No email is sent if the status has changed again within the **Time delay**.

5. In the **Job status** area, define whether an e-mail is also to be sent if a certain job progression is reached or when a certain quantity is reached.
6. Select the **E-Mail recipient** tab.
7. Select the e-mail recipient.

Option	Description
<b>As specified in Settings</b>	Send an e-mail to the recipient specified under <i>Settings</i> .
<b>Selected recipients</b>	Send an e-mail to the specified recipient (s). Multiple recipients are separated by a semi-colon (;).
<b>Define a recipient per tier</b>	Send an e-mail to the specified recipient (s) per tier.

Option	Description
	Multiple recipients are separated by a semi-colon (;).

- Click on **OK** to save the settings.
  - Status transmission has been enabled.
  - In the control station display of WIN slave performance, the **Status transmission activated**  symbol appears.

### 3.1.8 Report

A report can be generated for each view. In the **Control station main view**, the report takes into account all WIN slaves. In the user-defined views, the report takes into account the WIN slaves contained in the respective view.

- Call up the required view.
- Click on **Report / Export** in the toolbar.
  - The **Generate report** window appears.

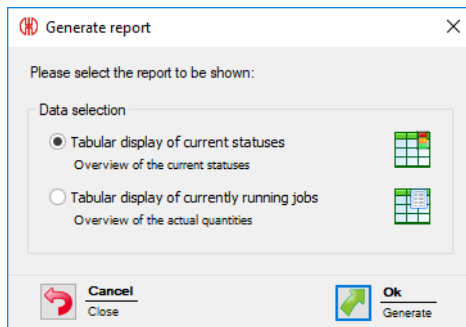

- Select the required report in the **Data selection** area.
- Click on **OK**.
  - The report is generated.
  - The *Print preview* for the report appears.

## 3.2 Productivity

The capacity of the machines can be analysed for any time intervals in the **Productivity** module. Work shifts, errors and downtimes can therefore be detected retrospectively, for instance for the last working day or for defined time periods.

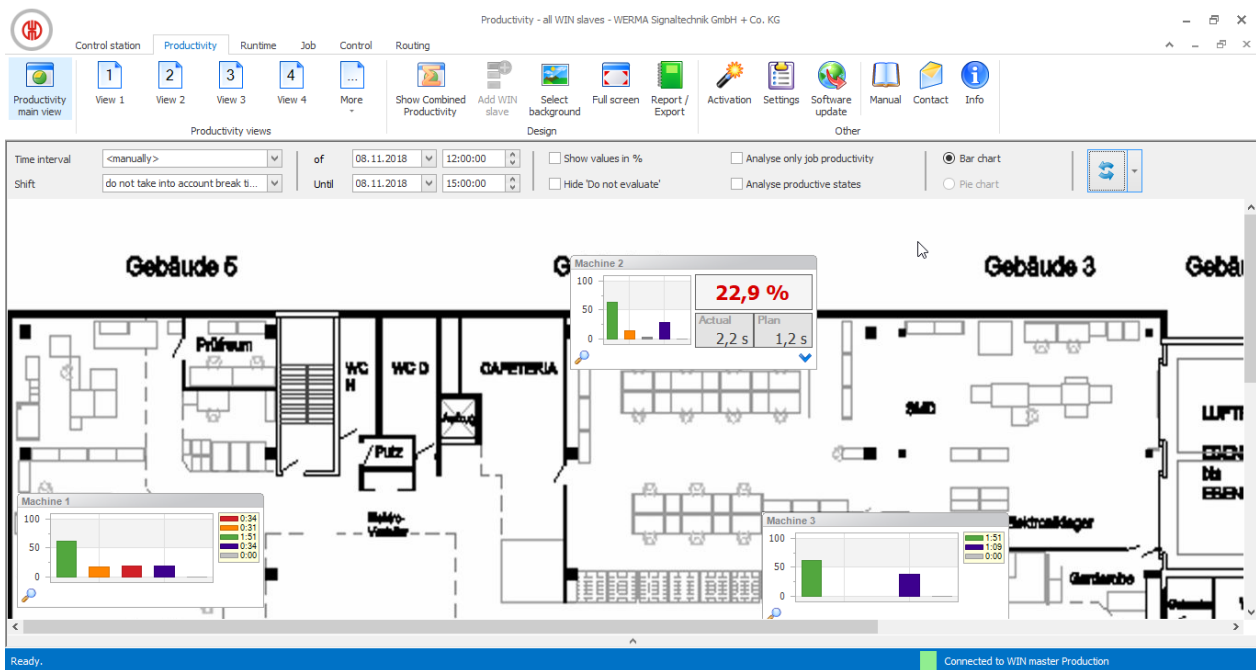

## 3.2.1 Views

The **Productivity main view** or a user-defined view can be used in the **Productivity** module.

### 3.2.1.1 Productivity main view

The **Productivity main view** gives an overview of all WIN slaves that have been configured. The **Productivity main view** can be provided with a background image.

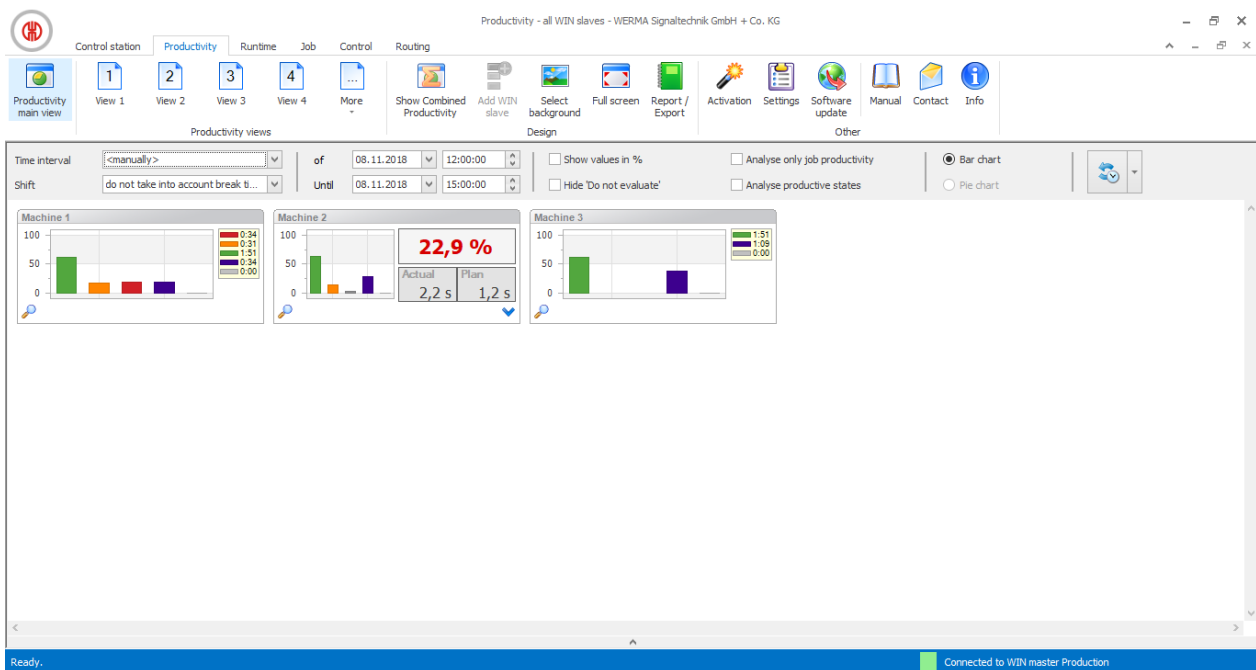

### 3.2.1.2 User-defined views

Additional user-defined views can be created in addition to the **Productivity main view**.

The user-defined views can be named as required and be provided with a background image. Different WIN slaves can be displayed in every user-defined view.

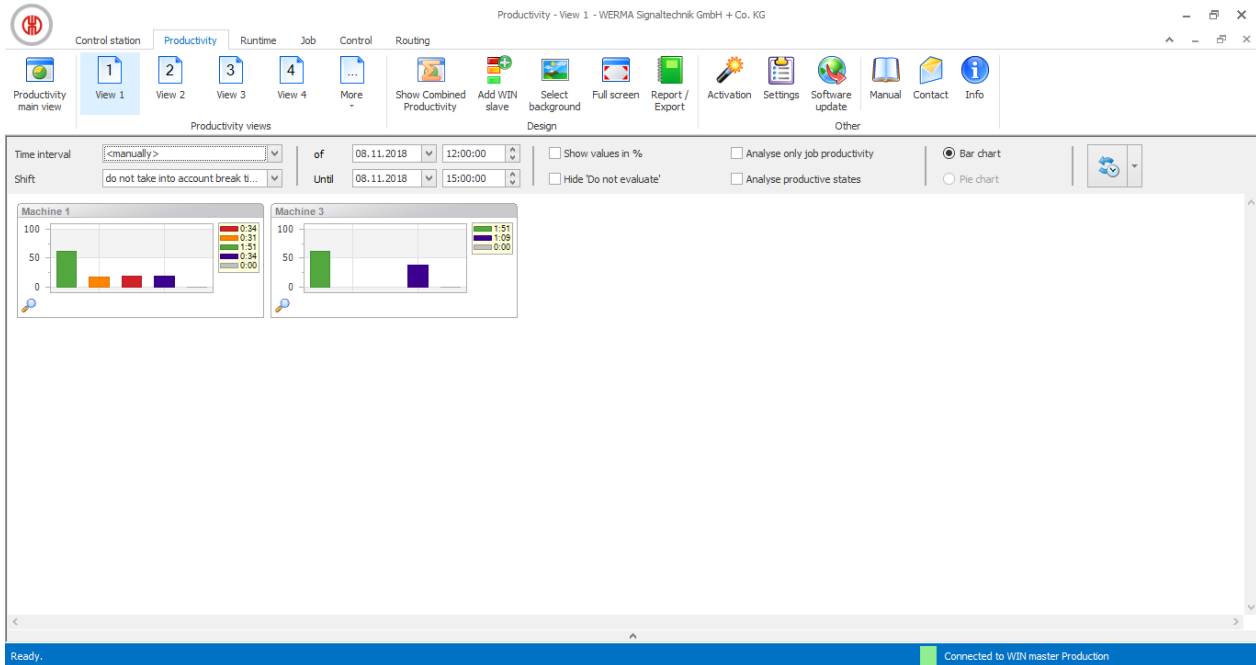

The user-defined views of the **Control station**, **Productivity** and **Runtime** modules are always identical. All view settings are applied.

### Adding WIN slave to a view

1. Call up the required view.
2. Click on **Add WIN slave**.  
→ The **Select WIN slave** window appears.

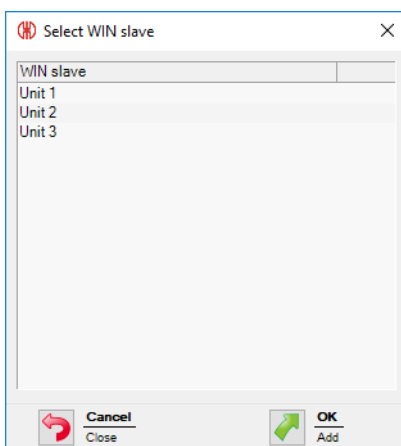

3. Highlight the required WIN slave.

4. Click on **OK**.  
→ The WIN slave has been added to the view.

### Deleting WIN slave from the view

1. Call up the required view.
2. Right-click on the WIN slave to be deleted.
3. Select **Remove** in the pop-up menu.

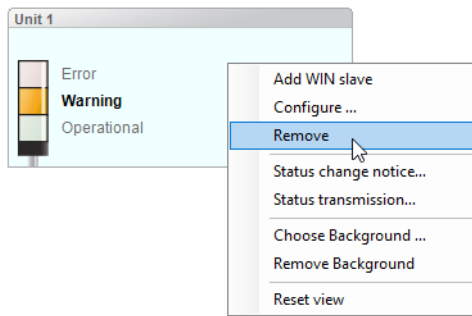

4. Confirm the prompt with **Yes**.  
→ The WIN slave has been deleted from the view.

### Selecting the background image of a view

1. Call up the required view.
2. Click on **Select background**.  
→ The **Background image** window appears.

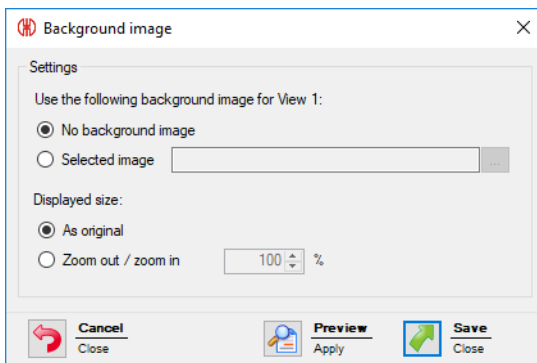

3. Select **Following** option.
4. Click on **Browse** and open the required background image.

---

**i** The background image needs to be saved on the local PC.  
If more than one computer is accessing a WERMA-WIN database, then the background image must be saved on a network drive.

---

5. Select **As original** option to paste the background image in its original size.
6. Select **Zoom out / zoom in** option to paste the background imaged scaled.

**i** Clicking on **Preview** allows a **preview** of the background image to be displayed.

7. Click on **Save** to paste the background image into the view.

### Repositioning a WIN slave

Every WIN slave can be repositioned anywhere in the view.

1. Left-click on the name of the WIN slave and hold down the mouse key.



2. Drag the WIN slave to the desired position and release the mouse key.

#### 3.2.1.3 Full-screen mode

Every view can be displayed in full screen and without the menu bar.

1. Call up the required view.
2. Click on **Full screen** in the menu bar.

To exit the full screen view:

1. Press **ESC**.

### 3.2.2 Productivity view

The diagrams in the productivity display show the individual statuses of the WIN slaves. The diagrams can be shown as pie charts or as bar charts.

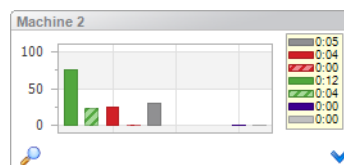
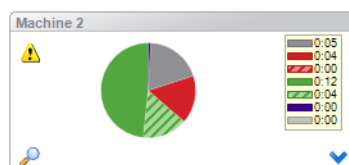

The displayed statuses of the WIN slaves correspond to the settings entered in the **Control station module**. The **Off** and **Connection error** statuses are also displayed. Blink recognition is shown by hatched areas in the diagram.

**i** The bars in the bar chart are always shown in the same order.

**Off** and **Connection error** statuses occur in the following cases:

Status	Description
Off	Signal tower is off but is supplied with power.
Connection error	<p>No radio connection between WIN slave and WIN master.</p> <p><b>WERMA WIN 4 Server Service</b> and <b>WERMA WIN 4 Connector Service</b> have not started.</p> <p>PC with WERMA-WIN database (Server PC) is switched off.</p> <p>Microsoft SQL server cannot be accessed and there is no connection to the WERMA-WIN database.</p> <p>There is no power supply to the WIN slave.</p> <p>WIN master is not connected to the PC.</p>

 A yellow warning triangle  indicates a signal overlap.

### 3.2.2.1 Modifying the productivity display

The time interval of the values displayed can be modified in the options bar.

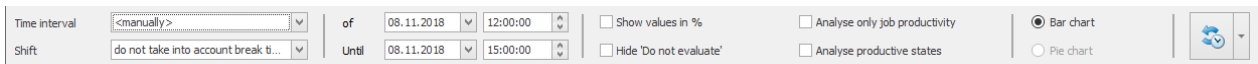

The screenshot shows an options bar with the following elements:

- Time interval:** A dropdown menu set to '<manually>', followed by 'of' and two date/time pickers set to '08.11.2018 12:00:00'.
- Shift:** A dropdown menu set to 'do not take into account break ti...', followed by 'Until' and two date/time pickers set to '08.11.2018 15:00:00'.
- Checkboxes:**
  - Show values in %
  - Analyse only job productivity
  - Hide 'Do not evaluate'
  - Analyse productive states
- Radio buttons:**
  - Bar chart
  - Pie chart
- Refresh icon:** A circular arrow icon on the right side.

The values displayed can be further filtered and modified using additional options. The following options are available:

Option	Description
<b>Time interval</b>	Select pre-set time interval or select <b>&lt;manually&gt;</b> and enter the time interval in the <b>From</b> and <b>Until</b> fields.
<b>Shift</b>	<p>Enter a certain shift and influence of pause times on the calculation.</p> <ul style="list-style-type: none"> <li>– <b>Do not take into account pause times:</b> Ignore shifts entered in the calculation.</li> <li>– <b>Only productive times:</b> Take shift model into account in the calculation.</li> <li>– <b>Single shift:</b> Only calculate the selected shift as the time period. All times outside of the shift are calculated as pause times.</li> </ul>
<b>Show values as a %</b>	Display runtime as a percentage.
<b>Hide 'Do not analyse'</b>	Ignore all statuses defined as <b>Do not analyse</b> in the WIN slave configuration and do not display them in the diagram.
<b>Analyse only job productivity</b>	Ignore with all WIN slave performance times without job.
<b>Analyse productive states</b>	Display all statuses defined as <b>Productive</b> and/or <b>Non productive</b> in the WIN slave configuration in the diagram.
<b>Bar chart</b>	Represent productivity in a <i>Bar chart</i> .



Option	Description
<b>Pie chart</b>	Represent productivity in a <i>Pie chart</i> .
	Update productivity display manually.  Enable automatic update and define the update interval.

To modify the productivity display:

1. Select the pre-set time interval in the **Time interval** selection list or enter another time interval in the **From** and **Until** fields.
2. Enable or disable additional options if necessary.
3. Click on **Update**.

### 3.2.2.2 Updating the productivity display

The productivity display can be updated manually or automatically.

#### Updating the productivity display manually

1. Click on **Update**  in the options bar.

#### Updating the productivity display automatically

1. Click on **Update** in the options bar.
2. Enable **Auto update**.
3. Enter the update interval in the **after** field.

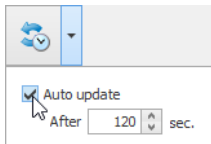

### 3.2.2.3 Zoom in or zoom out of the productivity display

1. Click on the magnifying glass  in the productivity display.
  - You zoom into or zoom out of the productivity display.
  - The descriptions of the tiers of the signal tower are also displayed in the zoomed in display.

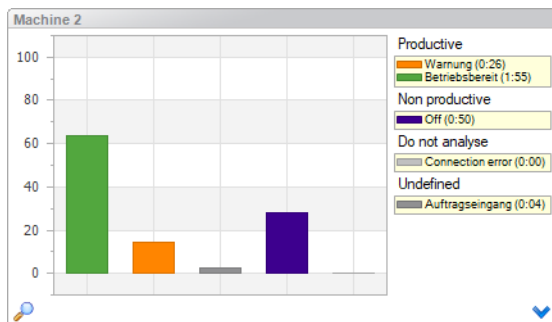

### 3.2.2.4 Representation versions WIN slave and WIN slave control

The productive statuses can be represented as a bar chart or pie chart with WIN slave and WIN slave control.

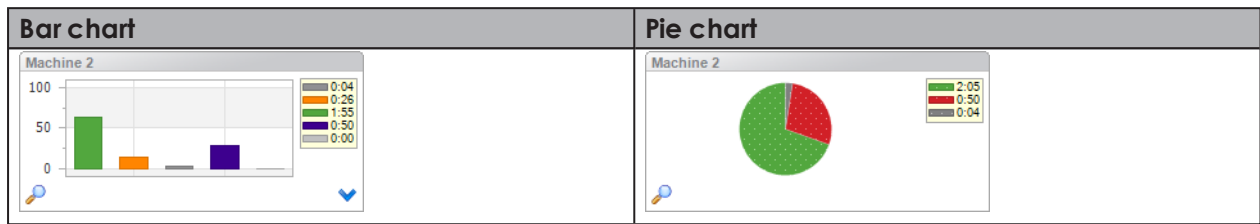

#### Switching between pie chart and bar chart

1. You can enable or disable **Calculate productive statuses** in the options bar.

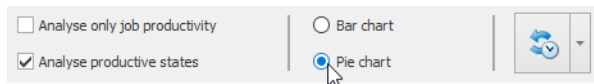

2. Click on **Update** in the options bar.

### 3.2.2.5 Display versions WIN slave performance

It is possible to choose between the following display versions with WIN slave performance. Productive statuses can also be displayed as a pie chart.

Display version	Representation	
Status		
Productivity		
Combined		
Productive statuses		

#### Selecting the representation version

1. Click on the arrow symbol .
  - The menu to select the representation version appears.

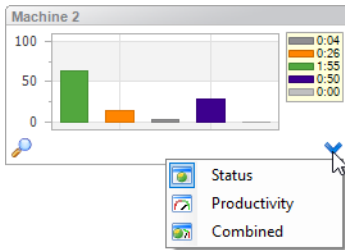

2. Select the representation version.
3. Click on **Update** in the options bar.

### Switching between pie chart and bar chart

1. You can enable or disable **Calculate productive statuses** in the options bar.

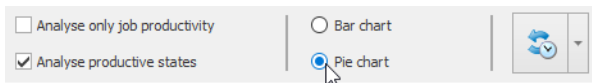

2. Click on **Update** in the options bar.

### 3.2.2.6 Combined productivity

Combined productivity can be shown in each view.

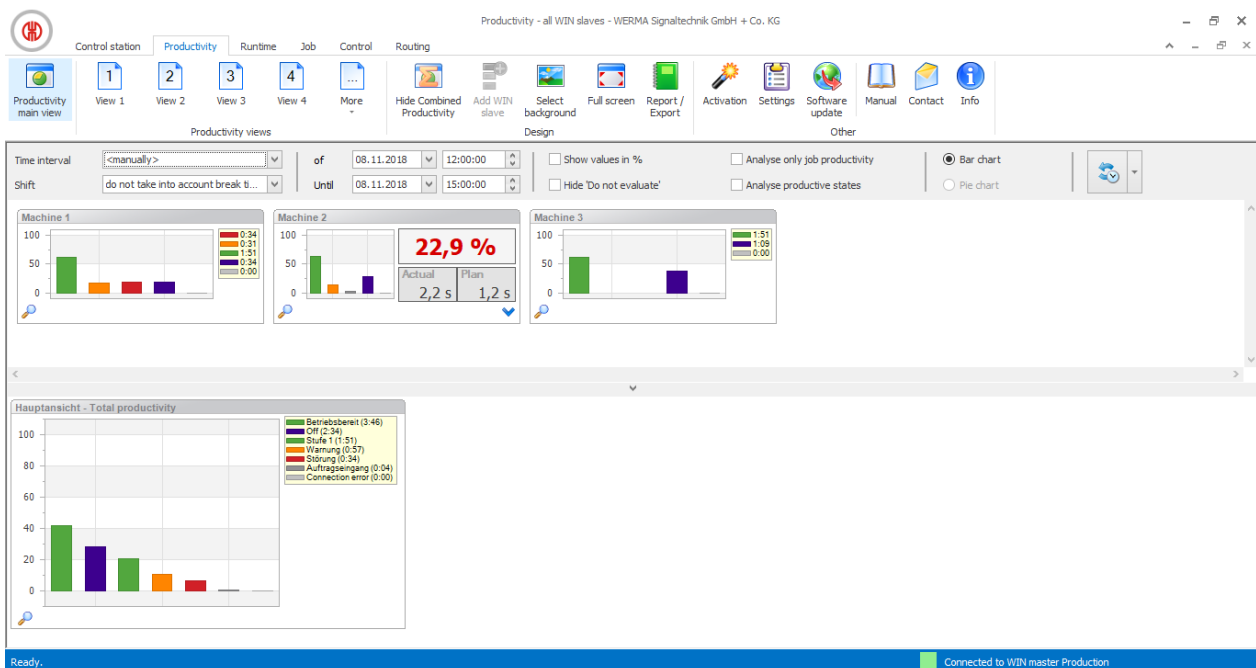

If the combined productivity is shown as a bar chart, the bars are not shown in the defined order but rather sorted according to the height of the bars.

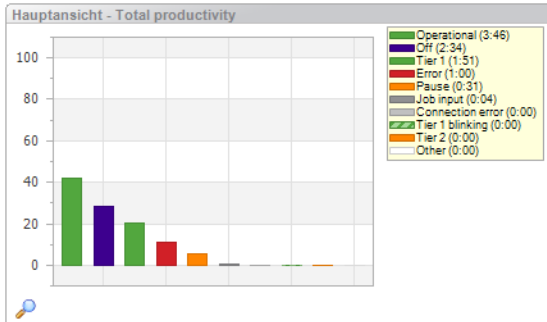

## Showing combined productivity

1. Click on the arrow at the end of the view.
- or -
2. Click on **Show combined productivity** in the toolbar.

## Hiding combined productivity

1. Click on the arrow above combined productivity.
- or -
2. Click on **Hide combined productivity** in the toolbar.

## 3.2.3 Report

A report can be generated for each view. In the **Productivity main view**, the report takes into account all WIN slaves. In the user-defined views, the report takes into account the WIN slaves contained in the respective view.



The report is generated with the times and settings defined in the Options bar.

1. Call up the required view.
2. Click on **Report / Export** in the toolbar.  
→ The **Generate report** window appears.

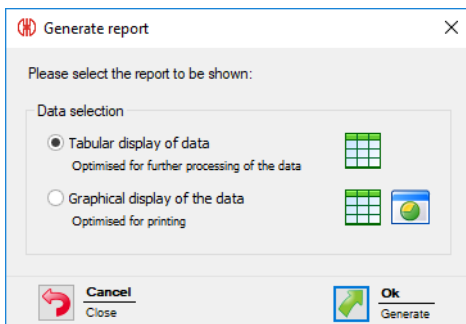

3. Select **Tabular display of data** or **Graphical display of data** option.
4. Click on **OK**.
  - The report is generated.
  - The *Print preview* for the report appears.

## 3.3 Runtime

The **Runtime** module shows an overview of the operation and downtimes of the machines monitored. This quickly detects patterns of downtime with machines, giving you improved transparency in the production process. This forms the basis for improving the efficiency of the machines monitored.

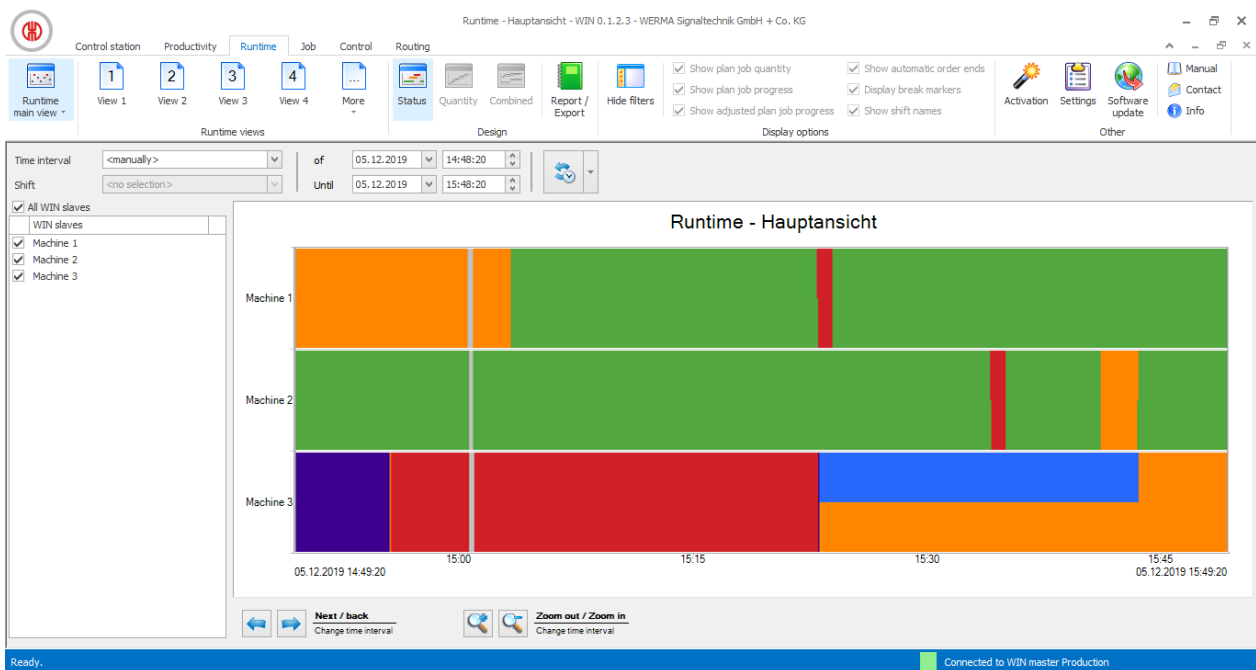

### 3.3.1 Views

The **Runtime main view** or a user-defined view can be used in the **Runtime** module.

#### 3.3.1.1 Runtime main view

The data of all WIN slaves already configured can be displayed in the **Runtime main view**.

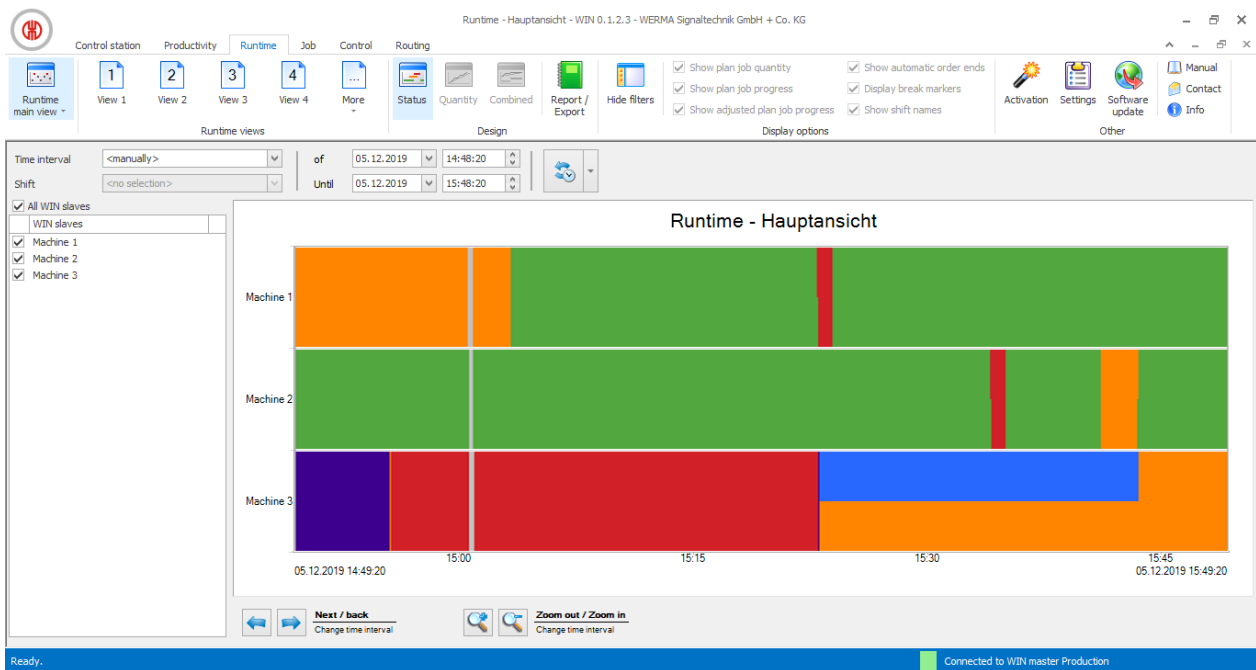

### 3.3.1.2 User-defined views

The user-defined views defined in the **Control station module** or **Productivity module** are available in addition to the **Runtime main view**. The user-defined views show an overview of the WIN slaves assigned in each case.

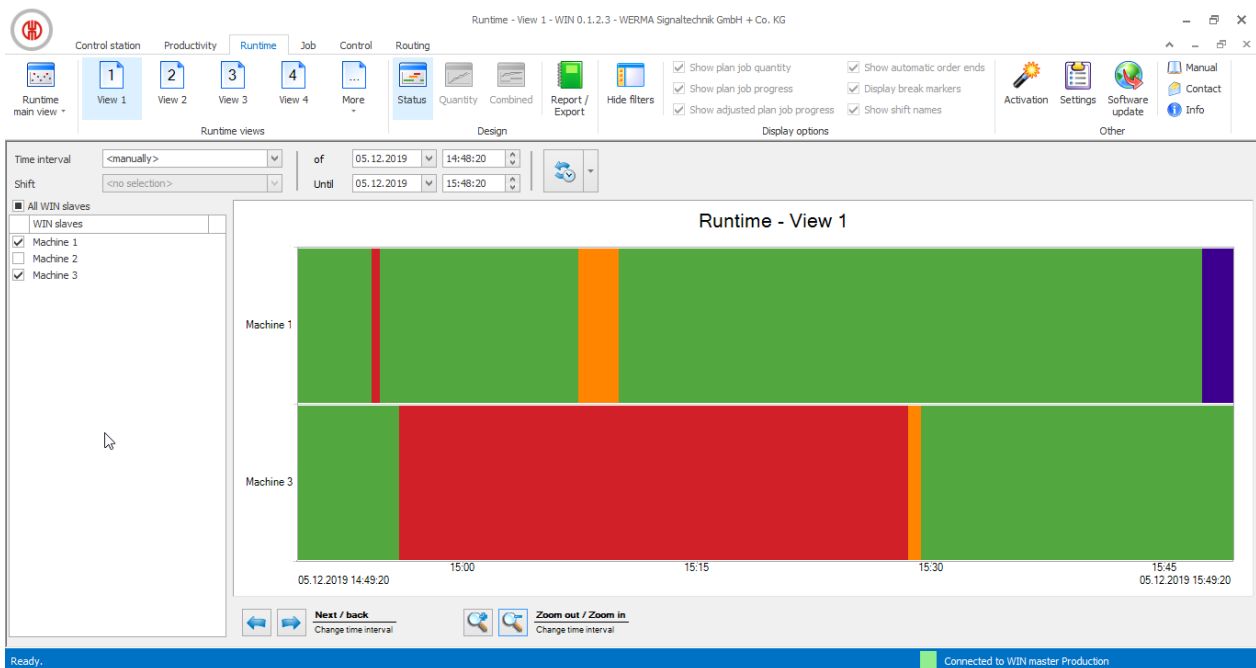

The user-defined views of the **Control station**, **Productivity** and **Runtime** modules are always identical. All view settings are applied.

### 3.3.1.3 Comparing multiple machines

Additional windows can be opened and arranged as required in the **Runtime main view** to compare multiple machines.

1. In the toolbar, expand **Runtime main view** by clicking on the arrow ▾.

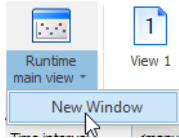

2. Select **New window**.  
→ A further window appears and can be arranged as required.

## 3.3.2 Runtime display

The runtime display shows a separate diagram for each WIN slave.

### 3.3.2.1 WIN slave and WIN slave control runtime display

The WIN slave and WIN slave control runtime display includes the following information:

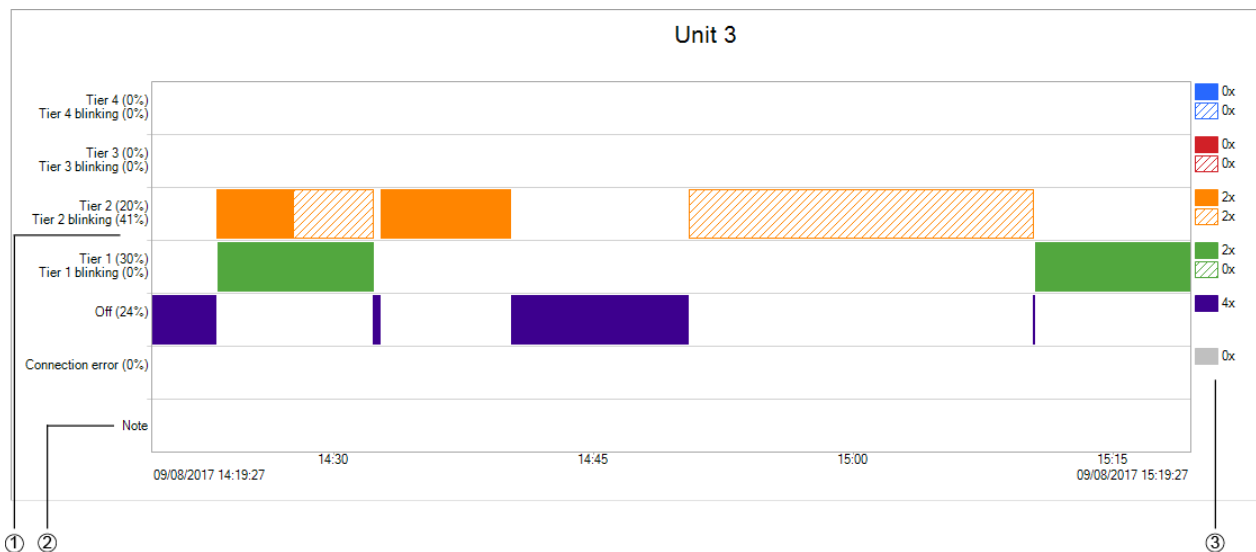

Item	Description
1	Design of statuses in the selected time interval
2	Note field
3	Quantity of statuses in the selected time interval
	The blink recognition signal is displayed as a shaded area in the colour of the respective tier.

**i** Following a power loss, the **Power loss** ⚠ warning symbol is displayed as soon as power is

**i** applied again to the WIN slave or WIN slave control. There may be incorrect data during the preceding time interval.

### 3.3.2.2 WIN slave performance

The WIN slave performance runtime display includes the following information:

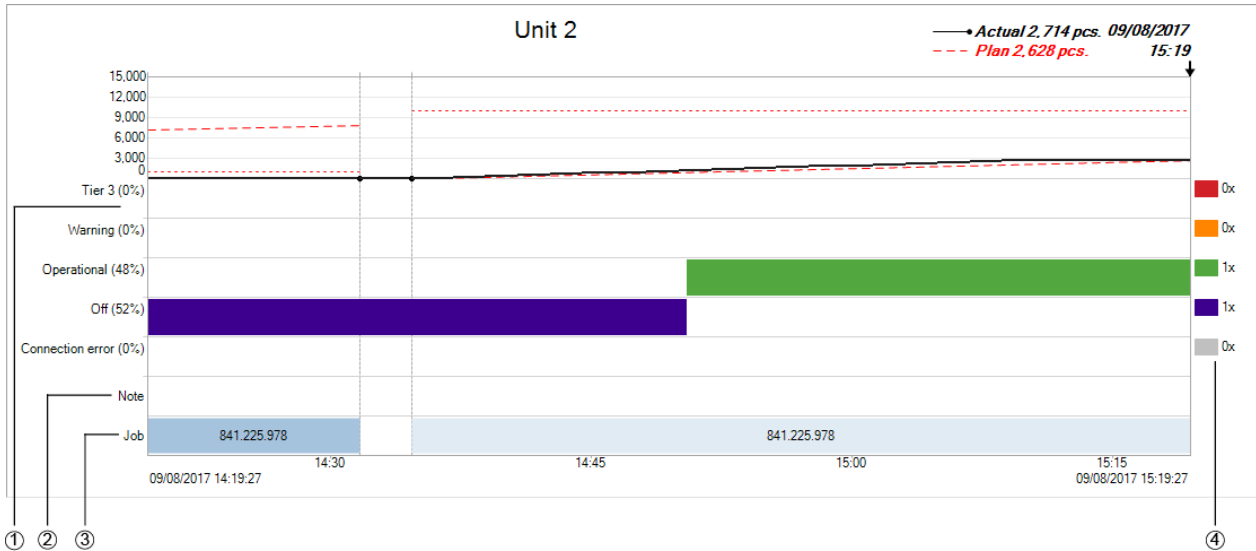

Item	Description
1	Status display/quantity display for the selected time interval depending on the display version
2	Note field
3	Job field
4	Quantity of statuses in the selected time interval
	The blink recognition signal is displayed as a shaded area in the colour of the respective tier.

**i** Following a power loss, the **Power loss** ⚠ warning symbol is displayed as soon as power is supplied again to the WIN slave performance. There may be incorrect data during the preceding time interval.

### 3.3.2.3 Modifying the runtime display

The time interval of the values displayed can be modified in the *Options bar*. Additional information can be shown or hidden in the *Display options*.

The buttons in the *Navigation bar* can be used to scroll through and zoom into the diagram displayed.



## Options bar

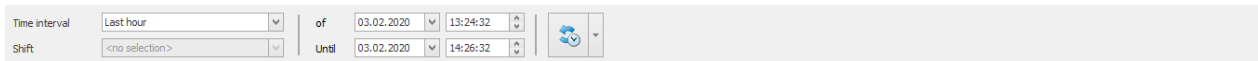

Time interval: Last hour | of: 03.02.2020 13:24:32 | Shift: <no selection> | Until: 03.02.2020 14:26:32 | [Refresh]

The values displayed can be further filtered and modified using additional options. The following options are available:

Option	Description
<b>Time interval</b>	Select pre-set time interval or select <b>&lt;manually&gt;</b> and enter the time interval in the <b>From</b> and <b>Until</b> fields.
<b>Shift</b>	Enter a certain shift and influence of pause times on the calculation. <ul style="list-style-type: none"> <li>– <b>Do not take into account pause times:</b> Ignore shifts entered in the calculation.</li> <li>– <b>Only productive times:</b> Take shift model into account in the calculation.</li> <li>– <b>Single shift:</b> Only calculate the selected shift as the time period. All times outside of the shift are calculated as pause times.</li> </ul>
	Update productivity display manually. Enable automatic update and define the update interval.

To modify the runtime display:

1. Select the pre-set time interval in the **Time interval** selection list or enter another time interval in the **From** and **Until** fields.
2. If necessary, enable or disable additional options in the *Display options*.
3. Click on **Update**.

### Showing or hiding the options bar

To hide the options bar and zoom into the representation of the diagram:

1. Click on **Display options** in the menu bar.
2. Click on **Hide filter**.

To show the options bar again:

1. Click on **Display options** in the menu bar.
2. Click on **Show filter**.

### Display options

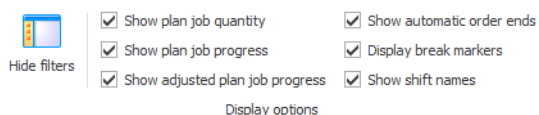

Hide filters |  Show plan job quantity |  Show automatic order ends  
 Show plan job progress |  Display break markers  
 Show adjusted plan job progress |  Show shift names

Display options

You can show or hide different information in a runtime diagram in the Display options, regardless of the WIN slave displayed. The following options are available:

Option	Description
 Hide filters	Show or hide options bar.
<b>Display job volume (plan)</b>	Display job volume in a diagram.
<b>Display job curve (plan)</b>	Display plan volume corresponding to the cycle time of the job in a diagram.
<b>Display modified job curve (plan)</b>	Display actual volume in a diagram. The pause times and volumes from other shifts will be taken into account.
<b>Display automatic job end</b>	Display job end in a diagram.
<b>Label pause markings</b>	Mark pause times in the diagram.
<b>Display shift names</b>	Display the names of the shifts in the diagram.



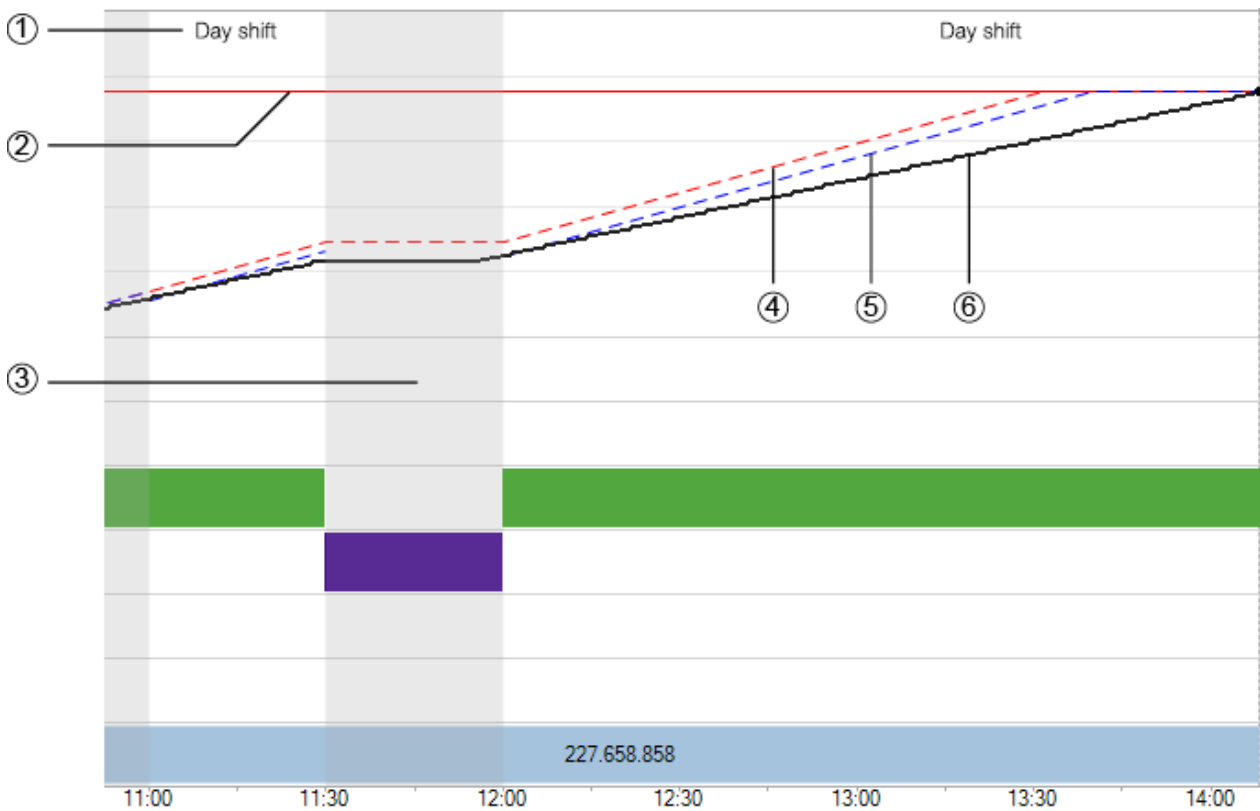

**Example:**

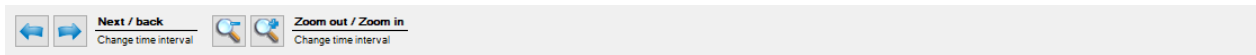

Item	Description
1	Shift name
2	Job volume (plan)
3	Pause
4	Job curve (plan)
5	Modified job curve
6	Quantity (actual)

## Navigation bar



Button	Function
	Show earlier time interval.
	Show later time interval.
	Zoom out of diagram and zoom into time interval displayed.
	Zoom into diagram and zoom out of time interval displayed.

### 3.3.2.4 Updating the runtime display

The runtime display can be updated manually or automatically.

#### Updating the runtime display manually

1. Click on **Update**  in the options bar.

#### Updating the runtime display automatically

1. Click on **Update** in the options bar.
2. Enable **Auto update**.
3. Enter the update interval in the **after** field.

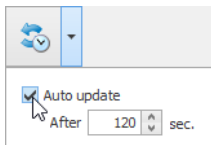

## 3.3.3 Notes/Fault conditions

Different notes or fault conditions can be entered for each WIN slave in the **Runtime** module.

### 3.3.3.1 Creating a note/fault condition

Notes or fault conditions can be created for defined time intervals.

The time interval of a note or fault condition can be defined in two ways:

- Manually defining the time interval of the note or fault condition
- Defining the time interval of the note or fault condition based on the duration of a status

## Manually defining the time interval of the note or fault condition

1. Double-click in the comment field in the WIN slave diagram.  
→ The **Edit note** window appears.
2. Enter the time interval in the **Start** and **End** fields.

## Defining the time interval of the note or fault condition based on the duration of a status

1. Click twice on a status in the WIN slave diagram.  
→ The **Edit note** window appears.

**i** If **Use touch interface to assign fault conditions** has been enabled under Settings, the display option for **Touch interface** appears instead of the **Edit note** window. A defined fault condition can only be selected in this case. It is not possible to create a note.

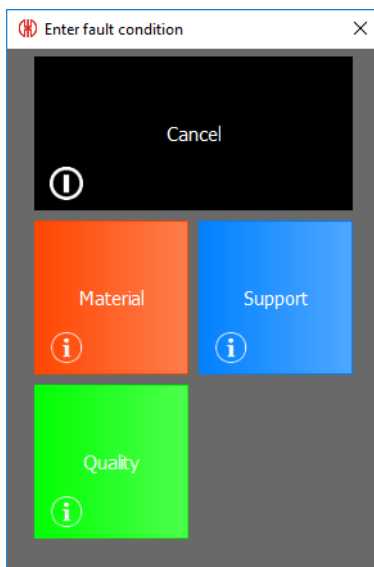

## Editing a note/fault condition

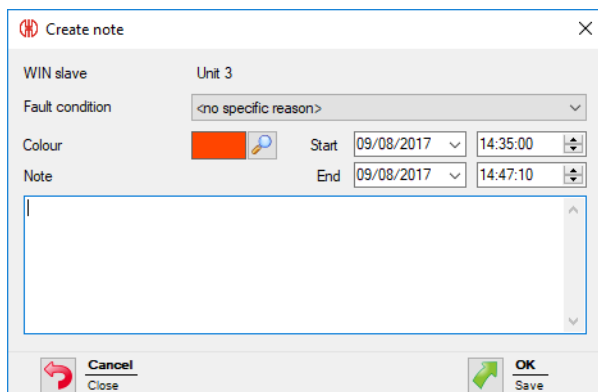

1. Select **Fault condition** in the selection list.

**i** Fault conditions must have previously been defined under *Settings*. The defined fault conditions can then be selected in the **Fault condition** selection list.

2. Select the **Colour**.
3. Modify the time interval in the **Start** and **End** fields.
4. Enter a note in the **Note** field.
5. Click on **OK** to save the note or fault condition.

### 3.3.3.2 Displaying a note/fault condition

1. Place the cursor on the note.  
→ The note is displayed in an information window.

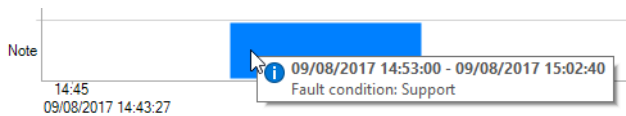

### 3.3.3.3 Editing a note/fault condition

1. Right-click on the required note.
  2. Select **Edit** in the pop-up menu.
- or -
1. Double-click on the required note.  
→ The **Edit note** window appears.

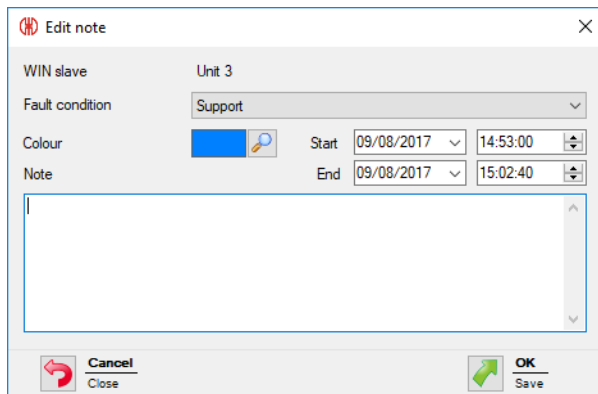

2. Modify the note as required.
3. Click on **OK** to save all changes.

### 3.3.3.4 Deleting a note/fault condition

1. Right-click on the note to be deleted.
2. Select **Delete** in the pop-up menu.

3. Confirm the prompt with **Yes**.  
→ The note has been deleted.

### 3.3.3.5 Limiting the view to the time interval of a note/fault condition

1. Right-click on the required note.
2. Check **Select time interval** in the pop-up menu.  
→ The view zooms in or out of the time interval of the note.

## 3.3.4 Job

If a job has been created in the Job module for a WIN slave performance, this appears in the diagram.

### 3.3.4.1 Displaying jobs

1. Place the cursor on the job or the associated line.  
→ The job information is displayed in an information window.

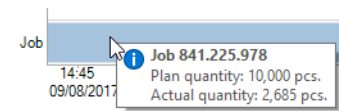

### 3.3.4.2 Limiting the view to the time interval of a job

1. Right-click on the job.

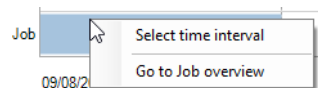

2. Check **Select time interval** in the pop-up menu.  
→ The view zooms in or out of the time interval of the job.

### 3.3.4.3 Displaying job information

1. Right-click on the job.

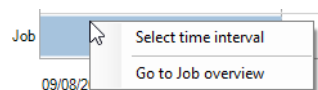

2. Select **Go to Job overview** in the pop-up menu.  
→ The **Job** module appears and displays the corresponding job.

### 3.3.5 Report

A report can be generated for each view. In the **Runtime main view** the report takes into account all WIN slaves. In the user-defined views, the report takes into account the WIN slaves contained in the respective view.

---

 The report is generated with the times and settings defined in the **Options bar**.

---

1. Call up the required view.
2. Click on **Report / Export** in the toolbar.  
→ The **Generate report** window appears.

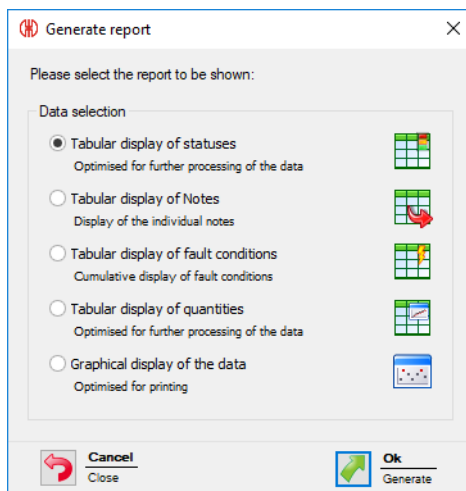

3. Select the required report in the **Data selection** area.
4. Click on **OK**.  
→ The report is generated.  
→ The *Print preview* for the report appears.

## 3.4 Job

The **Job** module shows which job is running on which machine and how far it has progressed.

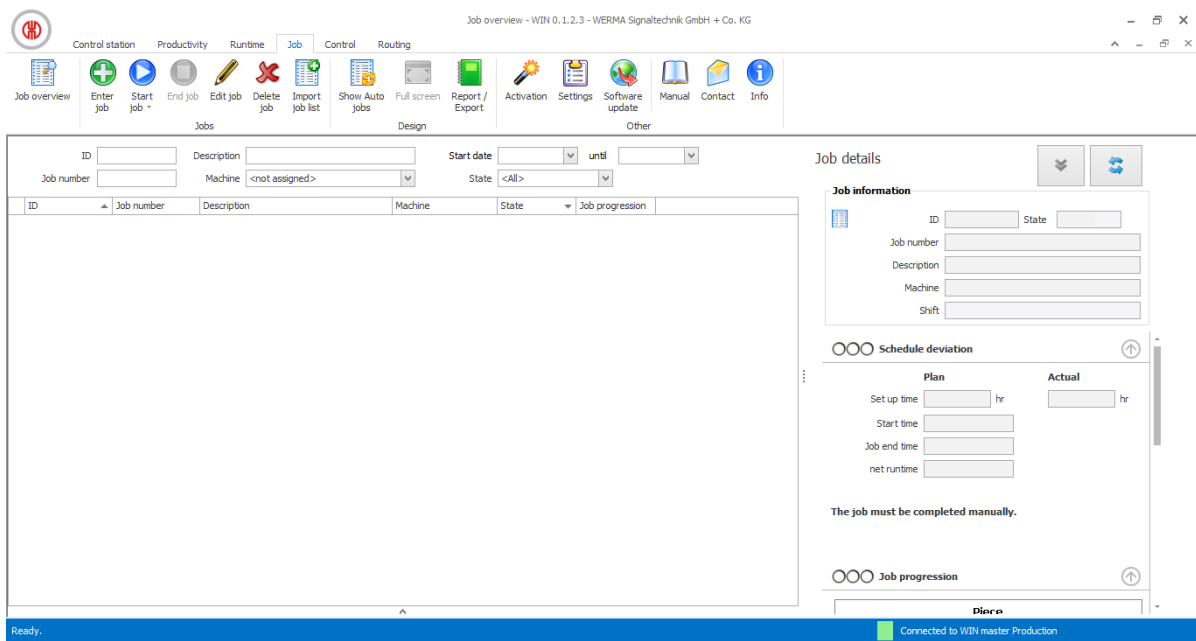

**i** No jobs can be created for WIN slave and WIN slave control.

### 3.4.1 Job overview

The job overview shows all jobs created with the relevant details. Auto jobs are listed in a separate area that can be *shown* and *hidden*.

ID	Job number	Description	Machine	State	Job progression
1	4856	841.225.978	Unit 2	Completed	104%
2	6483	846.365.978	<not assigned>	Waiting	0%
3	7984	207.866.124	<not assigned>	Waiting	0%
4	1472	114.458.323	<not assigned>	Waiting	0%
5	8952	846.365.978	<not assigned>	Waiting	0%
6	4856	841.225.978	Unit 2	Completed	26%
7	2323	842.715.777	Unit 2	Running	0%

Job number	Description	Machine	Activated	Weekday	Start time
2323	842.715.777	Unit 2	<input checked="" type="checkbox"/>	Mon, Thu, Fri	10:12
6578	759.681.956	Unit 2	<input checked="" type="checkbox"/>	Tue, Wed	12:12

**i** Clicking on the column name in the job overview lets you collate the displayed jobs in ascending or descending order.

The fields in the options bar can be used to filter and collate the displayed jobs.



ID  Description  Start date  until   
 Job number  Machine  State

### 3.4.1.1 Showing Auto jobs

1. Click on the arrow  at the end of the view.

- or -

1. Click on **Show Auto jobs** in the toolbar.

### 3.4.1.2 Hiding Auto jobs



1. Click on the arrow  above the Auto jobs overview.

- or -

1. Click on **Hide Auto jobs** in the toolbar.

## 3.4.2 Job details

Job details show all information on a job selected in the job overview.

Job details  

**Job information**



ID  State

Job number



Description

Machine

Shift

 **Schedule deviation +1,9 hr** 

	Plan	Actual
Set up time	<input type="text" value="0:00"/> hr	<input type="text" value="0:00"/> hr
Start time	<input type="text" value="09.08.2017 12:21"/>	<input type="text" value="09.08.2017 12:21"/>
Job end time	<input type="text" value="09.08.2017 12:38"/>	<input type="text" value="09.08.2017 14:31"/>
net runtime	<input type="text" value="2 hr 10 min."/>	<input type="text" value="2 hr 10 min."/>
Gross runtime	<input type="text" value="17 min. 0 sec."/>	<input type="text" value="2 hr 10 min."/>



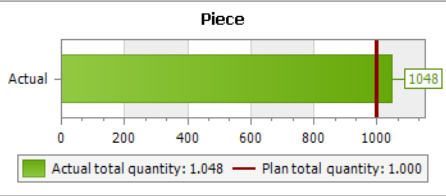

 **Job progression: 104%** 

**Piece**



Actual total quantity: 1.048 — Plan total quantity: 1.000

Amend actual quantity  Piece(s)



Button	Function
	Update job details and job overview.
	Switch to the <b>Productivity</b> or <b>Runtime</b> module.
	Hide area.
	Show area.

A traffic light display provides a quick overview of how well or poorly the job is running or has run in the **Schedule deviation**, **Job progression** and **Productivity** areas.

 The traffic light setting can be individually *modified* if required.

### 3.4.2.1 Schedule deviation

The **Schedule deviation** area displays information on the set-up, start, run and end time.

 Schedule deviation +0,0 hr 

Plan	Actual
Set up time: <input type="text" value="0:00"/> hr	<input type="text" value="0:00"/> hr
Start time: <input type="text" value="05.12.2019 14:10"/>	<input type="text" value="05.12.2019 14:10"/>
Job end time: <input type="text" value="05.12.2019 14:10"/>	<input type="text" value="05.12.2019 14:11"/>
net runtime: <input type="text" value="43 sec."/>	<input type="text" value="43 sec."/>
Gross runtime: <input type="text" value="22 sec."/>	<input type="text" value="43 sec."/>

The schedule deviation is specified in machine hours. 0.1 machine hours corresponds to 6 minutes, 1 machine hour corresponds to 60 minutes.

### 3.4.2.2 Job progression

The **Job progression** area displays information on the plan quantity and actual quantity.

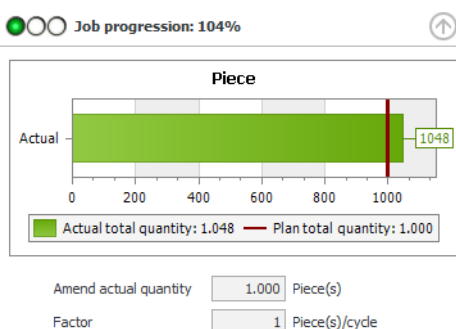

The current data is displayed for jobs currently running. The job progression is calculated as the ratio of the current actual quantity to the current plan quantity, expressed as a percentage.

The data for completed jobs is displayed at the end of the job. The job progression is calculated as the ratio of the actual quantity to the plan quantity, expressed as a percentage.

In addition, you can see the actual correction and the factor entered for this job.

### 3.4.2.3 Productivity

The **Productivity** area displays information on the plan cycle time and the actual cycle time.

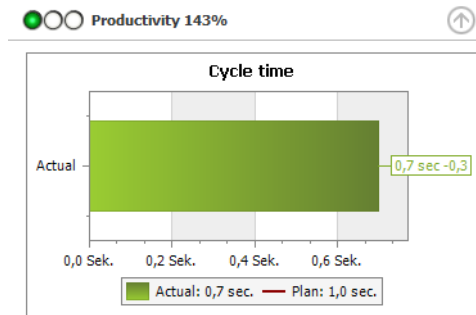

The current data is displayed for jobs currently running. The productivity is calculated as the ratio of the current actual cycle time to the current plan cycle time, expressed as a percentage.

The data for completed jobs is displayed at the end of the job. The productivity is calculated as the ratio of the actual cycle time to the plan cycle time, expressed as a percentage.

### 3.4.2.4 Editing traffic light settings

The traffic lights for **Schedule deviation**, **Job progression** and **Productivity** can be individually adapted.

The traffic light settings are saved in a local configuration file. You have to edit this local configuration file to change the traffic light setting.



The configuration file must be copied to transfer the altered traffic light setting to other PCs.

1. Open the following folder on your PC: C:\ProgramData\WERMA\WERMA-WIN-3.0 or C:\ProgramData\WERMA\WERMA-WIN-4.0.
2. Use a text editor (e.g. Notepad) to open the configuration file WERMA-WIN.ini.
3. Search for the following segment in the configuration file.

[Orders]

ProductivityGreenLimit=100  
ProductivityYellowLimit=75

CompletionGreenLimit=100  
CompletionYellowLimit=90

RuntimeGreenLimit=100  
RuntimeYellowLimit=110

Setting	Description	Example
<b>Productivity</b>		
ProductivityGreenLimit	Indicates up to what percentage the traffic light is switched to Green.	ProductivityGreenLimit=100 ProductivityYellowLimit=75 Productivity 0% to 74%: Traffic light is red
ProductivityYellowLimit	Indicates up to what percentage the traffic light is switched to Yellow.	Productivity 75% to 99%: Traffic light is yellow Productivity 100% or higher: Traffic light is green
<b>Job progression</b>		
CompletionGreenLimit	Indicates up to what percentage the traffic light is switched to Green.	CompletionGreenLimit=100 CompletionYellowLimit=90 Job progression 0% to 89%: Traffic light is red
CompletionYellowLimit	Indicates up to what percentage the traffic light is switched to Yellow.	Job progression 90% to 99%: Traffic light is yellow Job progression 100% or higher: Traffic light is green
<b>Schedule deviation</b>		
RuntimeGreenLimit	Indicates up to what percentage the traffic light is switched to Green.	RuntimeGreenLimit=100 RuntimeYellowLimit=110 Schedule deviation 0% or negative: Traffic light is green
RuntimeYellowLimit	Indicates up to what percentage the traffic light is switched to Yellow.	Schedule deviation 1% to 10%: Traffic light is yellow Schedule deviation greater than 11%: Traffic light is red

4. Save the configuration file once all changes have been made.

---

 The modified traffic light setting will be available as soon as WERMA-WIN is restarted.

---

### 3.4.3 Entering jobs

Jobs can be *manually* entered or imported from a *Job list*.

*Auto jobs* can be created for recurring jobs. Auto jobs start and stop the jobs automatically.

**i** An Auto job is only started if no other job is running on the selected WIN slave performance or has the status **Active waiting**.

### 3.4.3.1 Entering single jobs

1. Click on **Enter job** in the toolbar.  
→ The **Enter job** window appears.
2. Select the **Single job Type** in the **Job information** area.

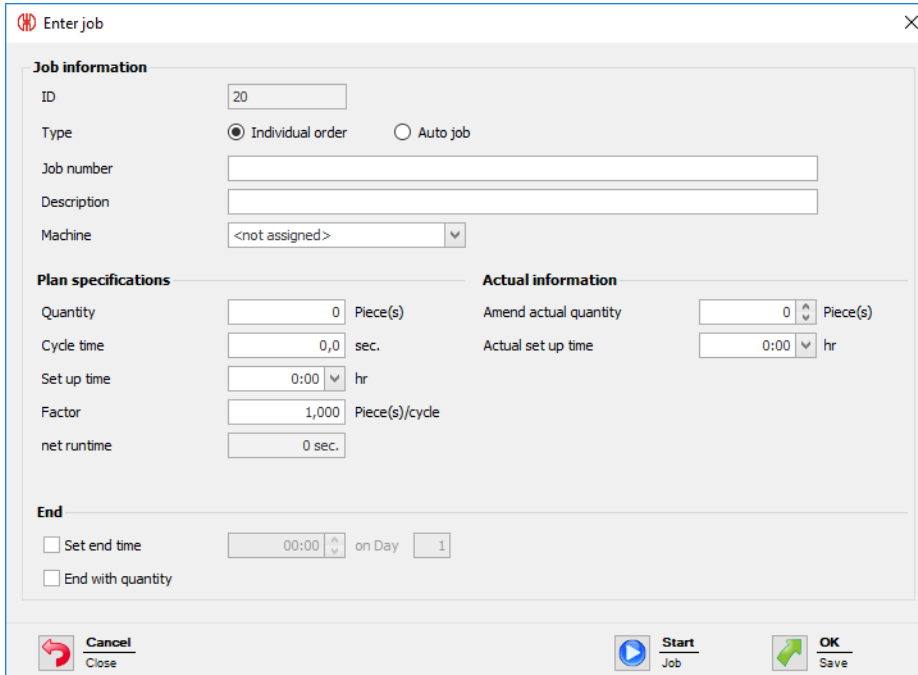

3. Enter your required **Job number** and **Description**.

**i** The **ID** is a continuous number and is automatically issued by WERMA-WIN.

4. Select the WIN slave performance on which the job is to run in the **Machine** selection list.
5. Enter the required plan values for the job in the **Plan specifications** area.

Plan value	Description
<b>Quantity</b>	Volume to be produced
<b>Cycle time</b>	Time needed to produce a part
<b>Set up time</b>	Set up time for the job If a part has been produced before the end of the set up time entered, the actual set up time is set to this time.
<b>Factor</b>	Quantity of pieces per cycle
<b>net runtime</b>	The time calculated by WERMA-WIN that is required to complete the job (including set up time, excluding pause times).

6. Enter the required actual values for the job in the **Actual value** area.

Actual value	Description
<b>Amend actual quantity</b>	Positive or negative correction values (e.g. with reject parts)
<b>Actual set up time</b>	Time from the start of job until the first quantity being transmitted WERMA-WIN system automatically sets the time which can be manually altered.

7. Enable **Stop at** in the **End** area and enter the end time if the job is to be completed at a certain time.

8. Enable **Stop when the plan quantity is reached** in the **End** area if the job is to be completed when the plan quantity is reached.

---

 If **Stop at** and **Stop when the plan quantity is reached** are enabled simultaneously, the job is stopped as soon as the end time or the plan quantity has been reached.

---

 There can be deviations relating to the actual quantity ( $\geq$  plan quantity) due to radio transmission.

---

Once all data has been entered:

1. Click on **Start** to start the job immediately.

- or -

1. Click on **OK** to save the job and set the status to **Waiting**.

### 3.4.3.2 Entering Auto jobs

1. Click on **Enter job** in the toolbar.  
→ The **Enter job** window appears.

2. Select the **Single job Type** in the **Job information** area.

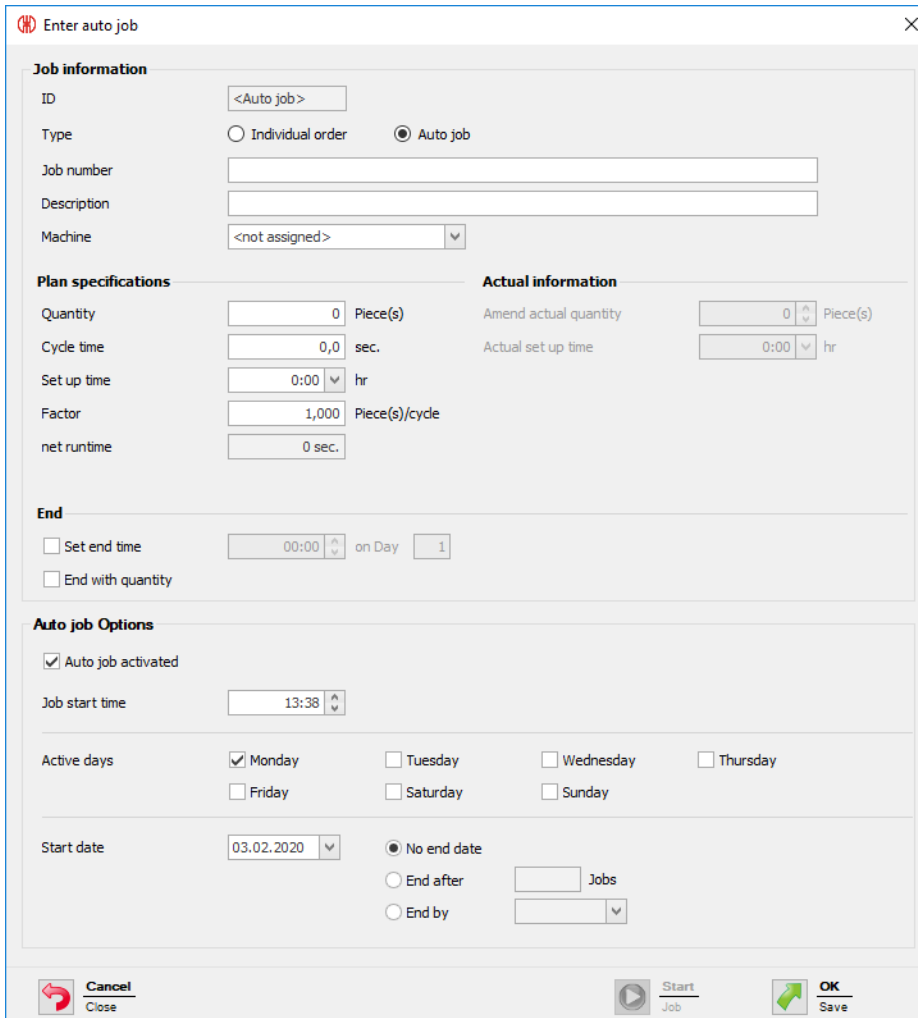

### 3. Enter your required **Job number** and **Description**.

 The **ID** is a continuous number and is automatically issued by WERMA-WIN.

4. Select the WIN slave performance on which the job is to run in the **Machine** selection list.

5. Enter the required plan values for the job in the **Plan specifications** area.

Plan value	Description
<b>Quantity</b>	Volume to be produced
<b>Cycle time</b>	Time needed to produce a part
<b>Set up time</b>	Set up time for the job If a part has been produced before the end of the set up time entered, the actual set up time is set to this time.
<b>Factor</b>	Quantity of pieces per cycle
<b>net runtime</b>	The time calculated by WERMA-WIN that is required to complete the job (including set up time, excluding pause times).

6. Enable **Stop at** in the **End** area and enter the end time if the job is to be completed at a certain time.
7. Enable **Stop when the plan quantity is reached** in the **End** area if the job is to be completed when the plan quantity is reached.

**i** If **Stop at** and **Stop when plan quantity is reached** are enabled simultaneously, the Auto job is stopped as soon as the end time or the plan quantity has been reached.

**i** There can be deviations relating to the actual quantity ( $\geq$  plan quantity) due to radio transmission.

8. Enter the required start time in the **Job start time** field in the **Auto job Options** area.
9. Select **Enabled** if the Auto job is to be enabled once it has been saved.
10. Enable the days on which the Auto job is to be performed in the **Active days** area.
11. Enter the start and end of the Auto job.

Field/Option	Description
<b>Start date</b>	Start date of Auto job
<b>No end date</b>	Auto job remains enabled until it is manually disabled.
<b>End after x jobs</b>	Auto job is disabled after the specified number of jobs.
<b>End by</b>	Auto job is disabled up to the specified time.

**i** WERMA-WIN checks for a duration of 1 year whether Auto jobs overlap. Overlapping Auto jobs cannot be saved.

12. Click on **OK** to save the Auto job.

### 3.4.3.3 Importing a job list

A job list can be imported in CSV format to create several jobs simultaneously.

#### Requirement:

- There is a CSV file available in a *suitable format*.

1. Click on **Import job list** in the toolbar.  
→ The **Import jobs** window appears.

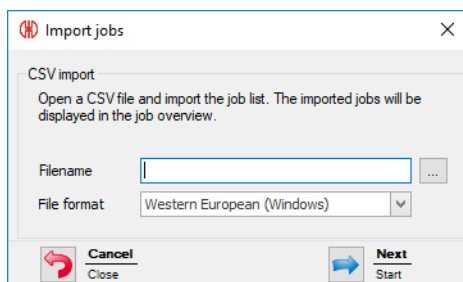



2. Click on **Browse**  and open the CSV file you require.
3. Adapt the **File format** if necessary.
4. Click on **Next**.
  - The CSV file is imported and checked.
  - If the check is successful, the jobs appear in the job overview.

### Format of the job list

The CSV file must meet the following requirements to correctly import a job list.

Column label or header:

- JOBNUMBER
- DESCRIPTION
- MACHINE
- QUANTITY
- CYCLETIME
- SETUP TIME
- FACTOR

Format rules:

- The Windows standard character set (for example Western European) or Unicode (UTF-8)
- Header or first row with column label must be specified.
- The delimiters are a semicolon (;), comma (,), Tabulator (\t) or pipe (|). Only one delimiter is allowed per document.
- SETUP TIME must be in the format [hh]h:mm (e.g. 0:00).
- CYCLETIME must be in seconds (e.g. 0.8).
- Decimal numbers must always use a point as a decimal separator (e.g. 0.8).
- Every data value can be placed in double quotation marks. The data value can therefore be a text. A semicolon (;) can occur in the text with quotation marks.
- One decimal place is allowed after the point for the cycle time (CYCLETIME).
- Three decimal places are allowed after the point for the factor (FACTOR).
- The maximum number of characters is checked.

Not relevant:

- The column order is not relevant (data is identified by the header).
- Column labels and headers are not case-sensitive.
- A maximum of 7 columns can be created. Not all columns need to be specified.

### Example:

JOBNUMBER	DESCRIPTION	MACHINE	QUANTITY	CYCLETIME	SETUP TIME	FACTOR
4800	"Round parts;4711" job	Machine 2	10000	0.8	01:00	2
4801	"Round parts;4500" job	Machine 3	15000	1.0	05:00	1
4802	"Round parts;3520" job	Machine 2	10000	0.7	01:00	2
4803	"Round parts;8466" job	Machine 5	20000	1.2	10:00	5
4804	"Round parts;0124" job	Machine 6	5000	1.5	01:50	1
4805	"Round parts;4500" job	Machine 2	50000	1.0	03:00	1

## 3.4.4 Starting jobs

Jobs can be started in the following way:

- Manually
- Quick start
- With the first pulse at the **Counter input** tier
- With the first pulse at the **Job input** tier

### 3.4.4.1 Starting a job manually

1. Select a job with the state **Waiting** in the job overview.
2. Click on **Start job** in the toolbar.  
→ The job is started.

- or -

1. Right-click on the job to be started.
2. Select **Start job** in the pop-up menu.  
→ The job is started.

### 3.4.4.2 Job quick start

Jobs from all modules can be started using a *keyboard shortcut*. Once the ID, job number or description has been entered, the program searches for a corresponding job and starts it immediately.

1. In the toolbar, expand **Start job** by clicking on the arrow ▾.

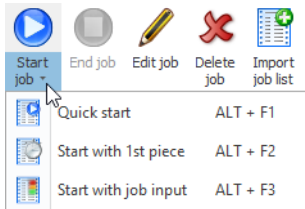

2. Select **Quick start**.  
→ The **Job quick start** window appears.

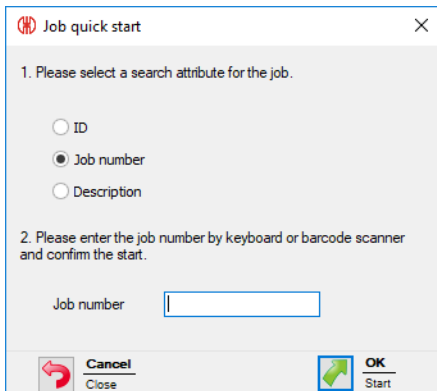

3. Choose the option the program is to search for.

4. Enter the value of the selected option into the corresponding field.
5. Click on **OK** to search for a job with the corresponding value.
  - If a job with the corresponding value is available, then it is started immediately.

### 3.4.4.3 Job start with 1st piece

Jobs can be started as soon as the first pulse to the **Counter input** tier of a WIN slave performance has been transmitted.

The job can be ended by a further pulse to the **Job input** tier.

1. Select a job with the state **Waiting** in the job overview.
2. In the toolbar, expand **Start job** by clicking on the arrow ▾.

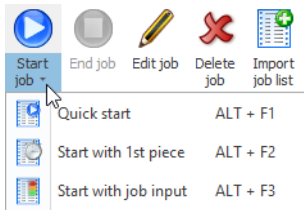

3. Select **Start with 1st Piece** in the pop-up menu.
  - The state of the job changes to **Active waiting**.
  - The job starts automatically as soon as the first pulse to the **Counter input** tier of a WIN slave performance has been transmitted.

- or -

1. Right-click on the job to be started.
2. Select **Start with 1st Piece** in the pop-up menu.
  - The state of the job changes to **Active waiting**.
  - The job starts automatically as soon as the first pulse to the **Counter input** tier of a WIN slave performance has been transmitted.

### 3.4.4.4 Job start with job input

Jobs can be started as soon as the first pulse to the **Job input** tier of a WIN slave performance has been transmitted.

The job can be ended by a further pulse to the **Job input** tier.

1. Select a job with the state **Waiting** in the job overview.
2. In the toolbar, expand **Start job** by clicking on the arrow ▾.

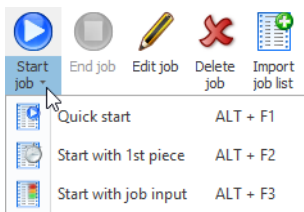

3. Select **Start with job input**.
  - The state of the job changes to **Active waiting**.

→ The job starts automatically as soon as the first pulse to the **Job input** tier of a WIN slave performance has been transmitted.

- or -

1. Right-click on the job to be started.
2. Select **Start with job input** in the pop-up menu.
  - The state of the job changes to **Active waiting**.
  - The job starts automatically as soon as the first pulse to the **Job input** tier of a WIN slave performance has been transmitted.

### 3.4.5 Completing jobs

1. Select the required job in the job overview.
2. Click on **End job** in the toolbar.

- or -

1. Right-click on the required job.
2. Select **End job** in the pop-up menu.

### 3.4.6 Activating Auto jobs

1. Enable the checkbox in the **Activated** column in the overview of Auto jobs.

Auto jobs

Job number	Description	Machine	Activated
2323	842.715.777	Unit 2	<input checked="" type="checkbox"/>

### 3.4.7 Disabling Auto jobs

1. Disable the checkbox in the **Activated** column in the overview of Auto jobs.

Auto jobs

Job number	Description	Machine	Activated
2323	842.715.777	Unit 2	<input type="checkbox"/>

### 3.4.8 Editing jobs

1. Select the required job in the job overview.
  2. Click on **Edit job** in the toolbar.
- or -
1. Right-click on the required job.
  2. Select **Edit job** in the pop-up menu.

→ The **Edit job** window appears.

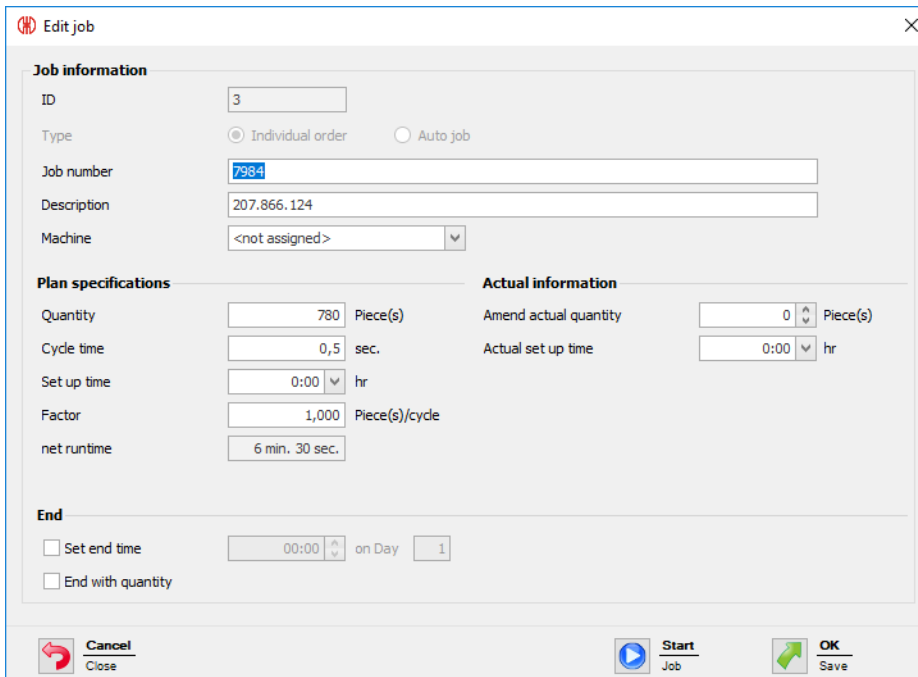

3. Edit the job information as required.

Once all data has been entered:

1. Click on **Start** to start the job immediately.

- or -

1. Click on **OK** to save the job and set the status to **Waiting**.

### 3.4.9 Correction of a completed job

1. Select the job with the state **Completed** in the Job overview.

2. Click on **Edit job** in the toolbar.

- or -

1. Right-click on the required job.

2. Select **Edit job** in the pop-up menu.

→ The **Edit job** window appears.

**Job information**

ID: 6

Type:  Individual order  Auto job

Job number: 4856

Description: 841.225.978

Machine: Machine 2

**Plan specifications**

Quantity: 3.700 Piece(s)

Cycle time: 0,5 sec.

Set up time: 0:00 hr

Factor: 1,000 Piece(s)/cycle

net runtime: 30 min. 50 sec.

**Actual information**

Amend actual quantity: 0 Piece(s)

Actual set up time: 0:02 hr

**End**

Set end time: 00:00 on Day 1

End with quantity

3. Change the job information as required.
4. Click on **OK** to save the settings.

### 3.4.10 Deleting jobs

1. Select the job in the job overview.
  2. Click on **Delete job** in the toolbar.
- or -
1. Right-click on the job to be deleted.
  2. Select **Delete job** in the pop-up menu.

### 3.4.11 Duplicating jobs

1. Right-click on the required job.
2. Select **Duplicate job** in the pop-up menu.  
→ The **Copy job** window appears.

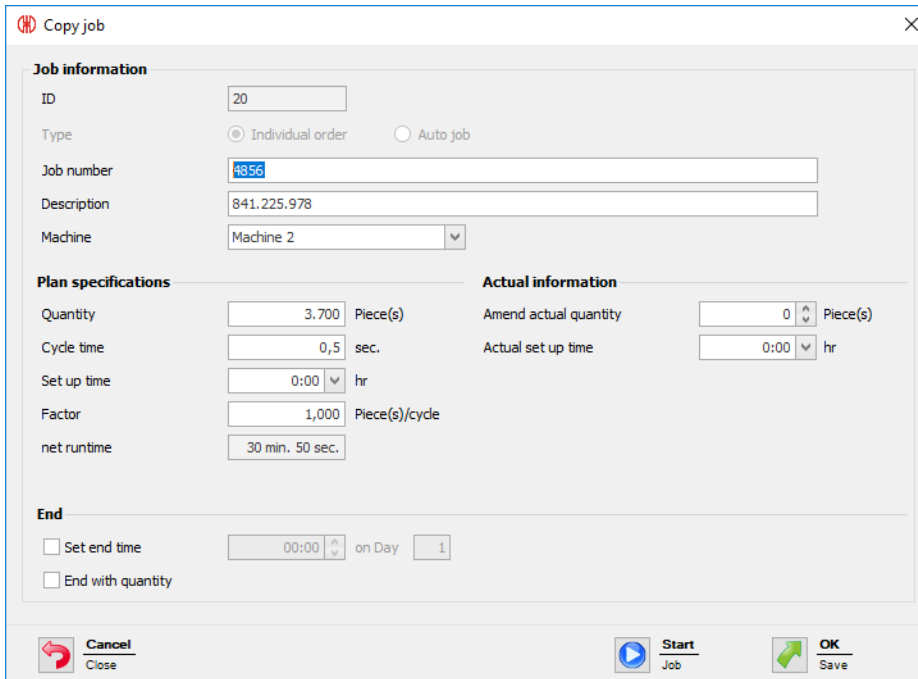

3. Modify the job information as required.
4. Click on **OK** to save the settings.

### 3.4.12 Report

A report can be generated for the filters currently selected and the current collation in the *job* overview. Only jobs on the machine are taken into account in the report as soon as a certain machine has been selected in the filter menu.

1. Adapting the required filters and collation.
2. Click on **Report / Export** in the toolbar.  
→ The **Generate report** window appears.

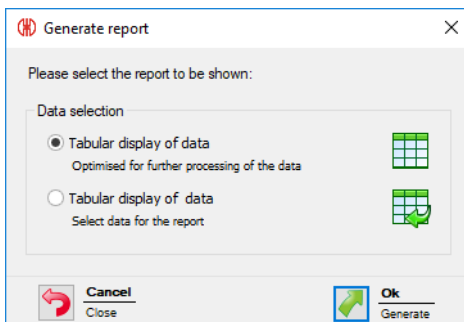

3. Select the required report in the **Data selection** area.



Selecting the **Tabular display of data** option allows the content of the report to be individually adapted.

4. Click on **OK**.
  - Selecting the **Tabular display of data** option generates the report and the *Print preview* is displayed.
  - Selecting the **Tabular display of data** option makes the window appear for further data selection.

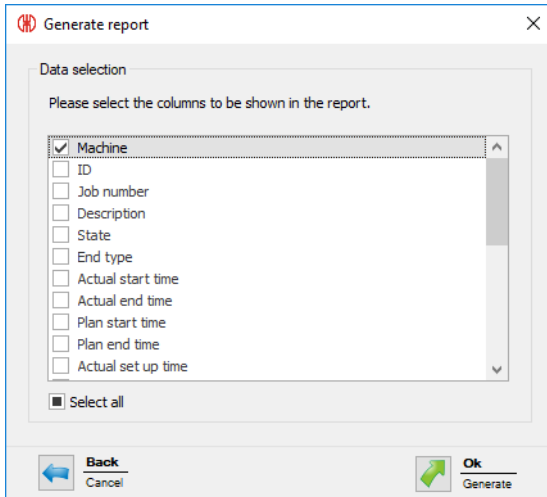

5. Adapting the report by enabling or disabling the individual buttons.
6. Click on **OK**.
  - The report is generated.
  - The *Print preview* for the report appears.

## 3.5 Control

In the **Control** module, rules with different logic functions can be defined, with which WIN slave control can be switched or controlled. The WIN slave included in the WERMA-WIN network can be used as the input signals for the logic functions.



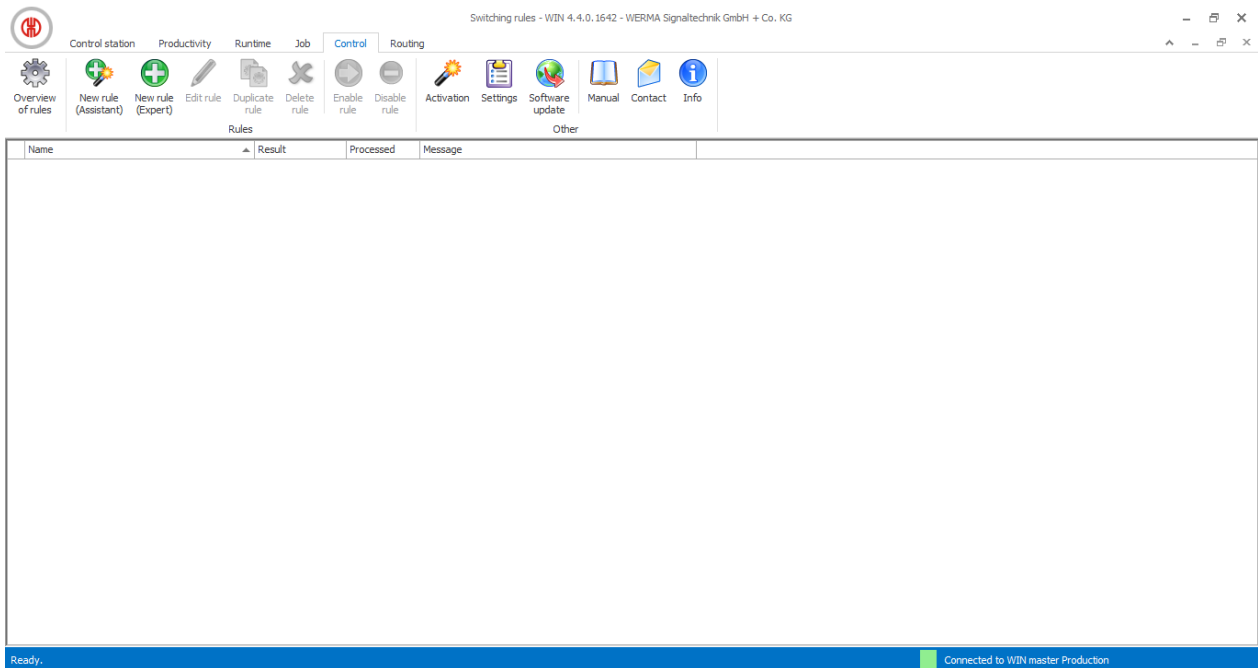

**i** No rules can be defined for WIN slave and WIN slave performance.

### 3.5.1 Overview of rules

The overview of rules shows a list of all switching rules that have been created and their current status.

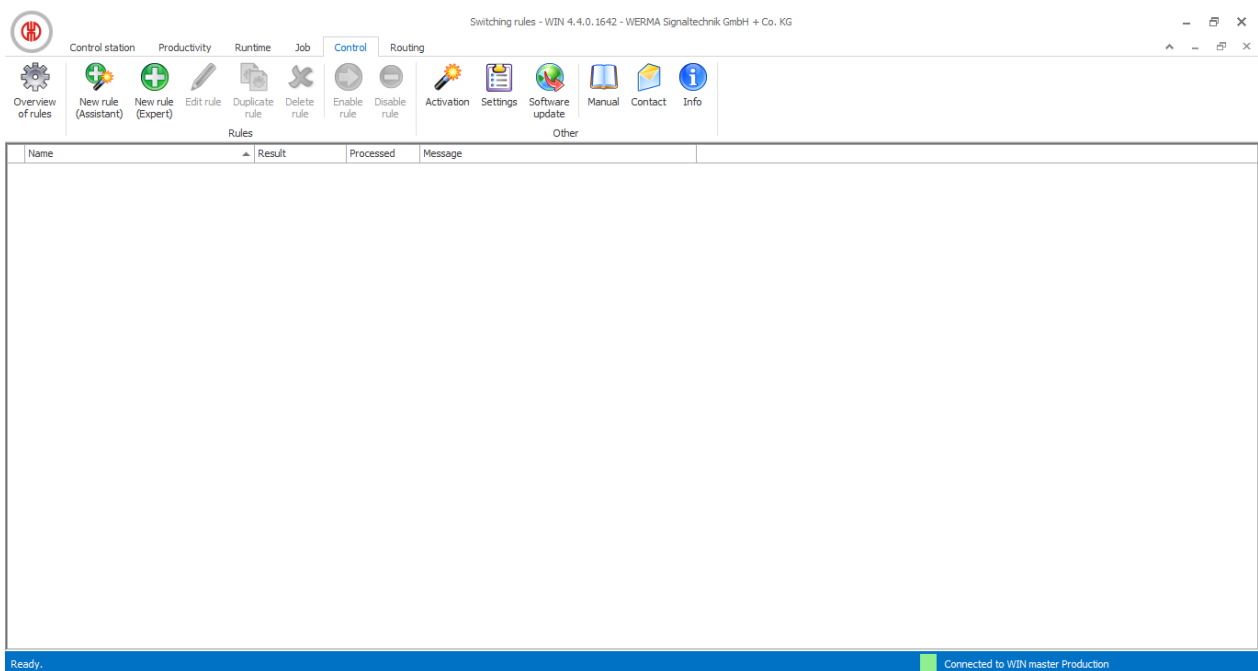

Column	Description
Name	Name of switching rule
Result	Current result of switching rules (e.g. On, Off, Blinking)
Processed	✓ = Switching rule being processed
	✗ = No connection to WIN slave control
	🕒 = Switch being processed
Message	More information on the rule

## 3.5.2 Defining new rules

New rules can be defined either using an *assistant*, which takes you step by step through the settings, or in an *Expert mode*.

### 3.5.2.1 Creating a new rule with assistants

1. Click on **New rule (Assistant)** in the toolbar.  
→ The **Define new switching rule** window appears and shows an example of a switching rule.

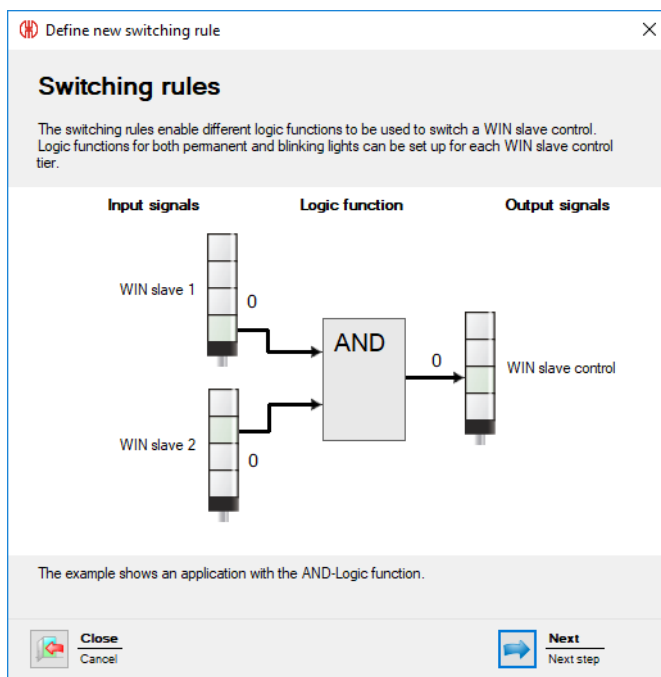

2. Click on **Next**.  
→ The window to select the logic function appears.

## Selecting the logic function

Define new switching rule
✕

**Logic function**

Please select the logic function to which the input signals should be assigned.

Description	Logic function
Each tier must be in the selected status	AND
At least one tier must have the defined status	OR
No tier may be in the defined status	NOR
Enter custom logic function (expert mode)	

**AND-Logic example**

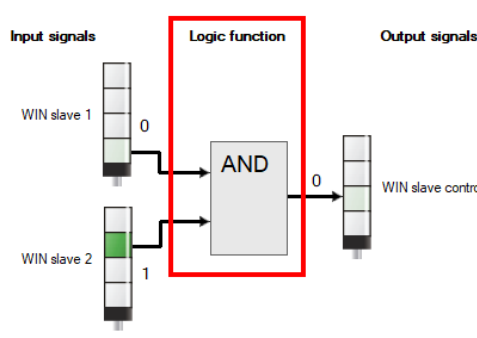

← Back  
Cancel
→ Next  
Next step

3. Select the **Logic function** with which the input signals are to be linked.

Logic function	Description
AND	Each tier must be in the selected status.
OR	At least one tier must have the selected status.
NOR	No tier may be in the defined status.

i The graphic on the right in the window shows an example of the logic function selected. You may wish to create *your own logic functions*.

4. Click on **Next**.

→ The window to select the input signal appears.

## Selecting the input signal

Define new switching rule
✕

**Input signals for AND-Logic function**

Please select the input signals to be assigned to switching rule AND.

WIN slave	Tier	Status

+ Add  
✎ Edit  
✖ Delete

**Switching delay**

If a switching delay is set up then the input signals must remain the same for the delay period.

Delay  sec.

**AND-Logic example**

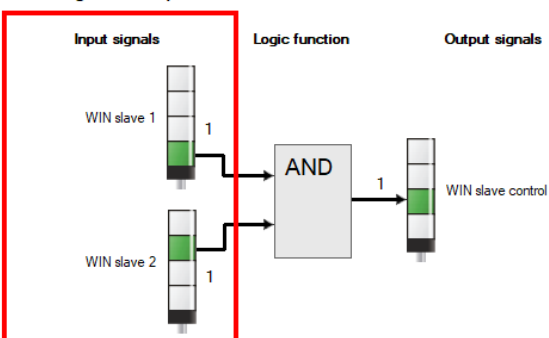

← Back  
Cancel
→ Next  
Next step

- Click on **Add** to select the input signals for the selected logic function.  
→ The **Select tier and status** window appears.

- i** The **Select tier and status** window shows all the WIN slaves included in the WERMA-WIN network. The available tiers and statuses correspond to the tiers and statuses *configured* in the **Control station** module.

The blinking status is only displayed if blink recognition is enabled for the tier.

- Select the WIN slave to be used as the input signal.
- Select the tier of the WIN slave to be used as the input signal.

- i** The counter input of a WIN slave performance cannot be used as input signal for a logic function.

- Select the status in which the selected tier is to be.
- Click **OK** to apply the settings.  
→ The **Define new switching rule** window appears and shows the input signal defined in the list.

- Click on **Add**, if necessary, to add an additional input signal.
- Click on **Edit**, if necessary, to modify the selected input signal.

12. Click on **Delete**, if necessary, to delete the selected input signal.
13. Set the switching delay in the **Delay** field.

 The switching delay defines how long all input signals have to be in the same status for the output signal to be switched.

14. Click on **Next**.  
→ The window for selection of the output signal appears.

### Selecting the output signal

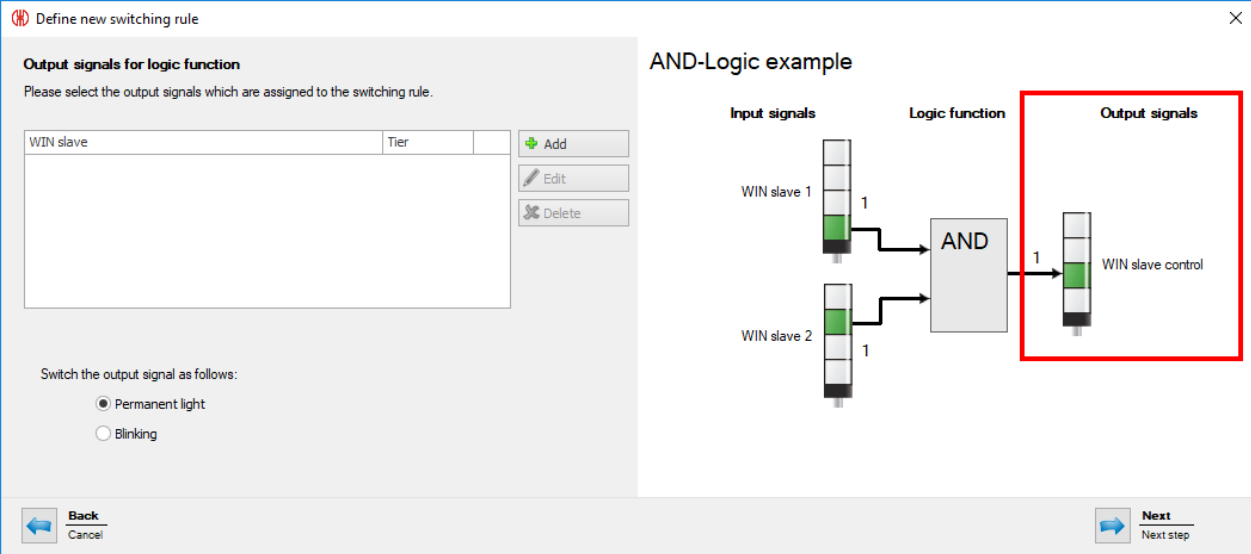

15. Click on **Add**.  
→ The **Select tier** window appears.

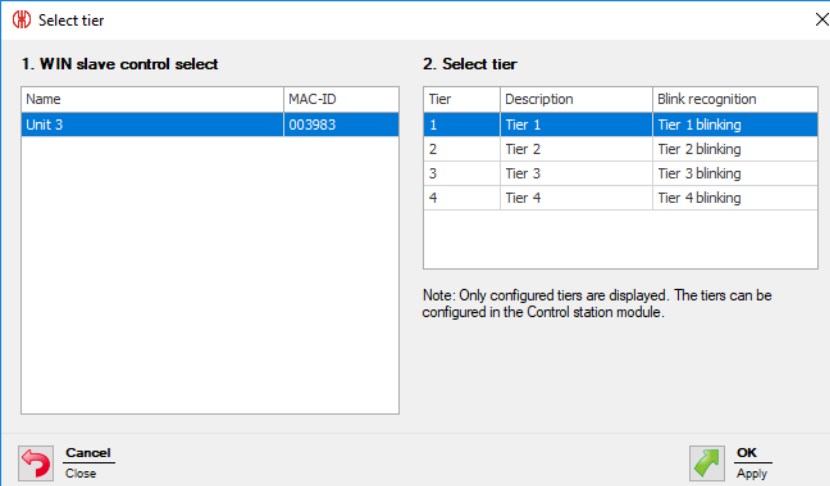

16. Select the WIN slave control to be used as the output signal.
17. Select the tier to be switched.
18. Click **OK** to apply the settings.

→ The **Define new switching rule** window appears and shows the input signal defined in the list.

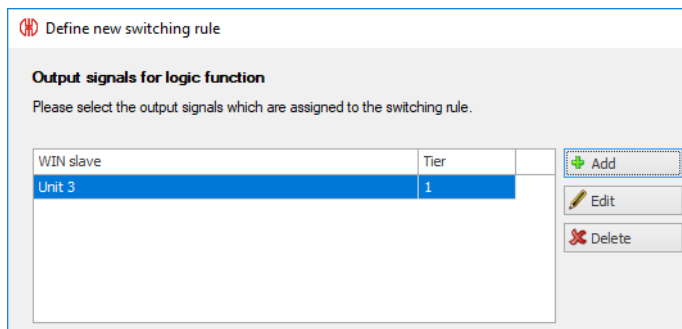

19. Click on **Add**, if necessary, to add an additional output signal.
20. Click on **Edit**, if necessary, to modify the selected output signal.
21. Click on **Delete**, if necessary, to delete the selected output signal.
22. Define whether the **Output signal** should be switched as a **Permanent light** or blinking.
23. Click on **Next**.

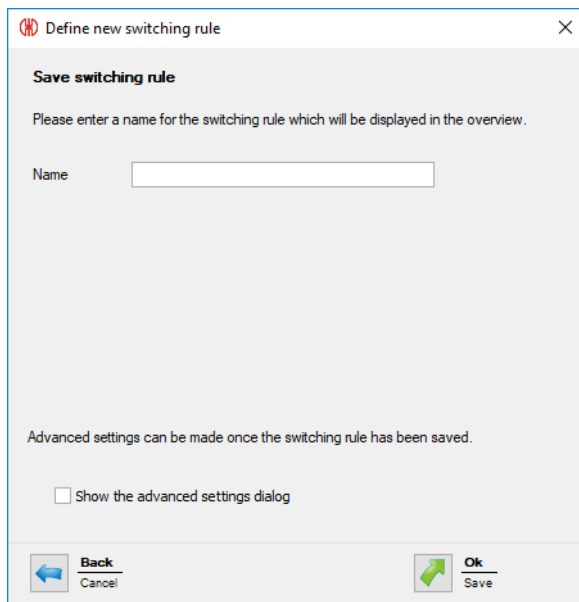

24. In the **Name** field, enter a name for the switching rule.
25. Enable **Show the advanced settings dialog** if more settings are to be entered for the switching rule.
26. Click on **OK** to save the switching rule.  
→ The switching rule appears in the rule overview and is enabled.

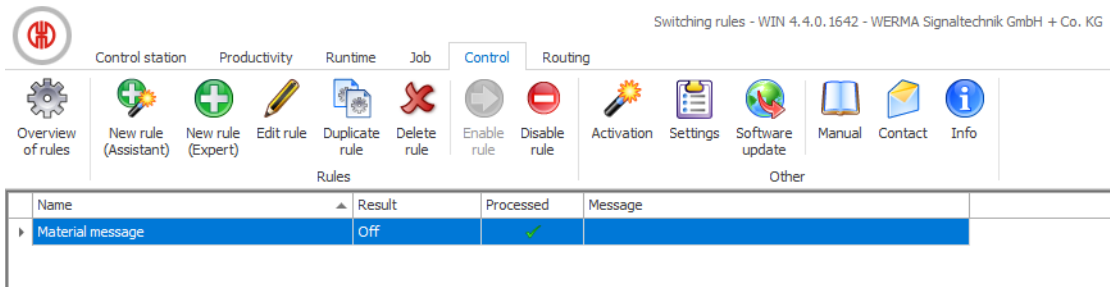

### 3.5.2.2 Defining new rules in Expert mode

1. Click on **New rule (Expert)** in the toolbar.  
→ The **Define new switching rule** window appears.

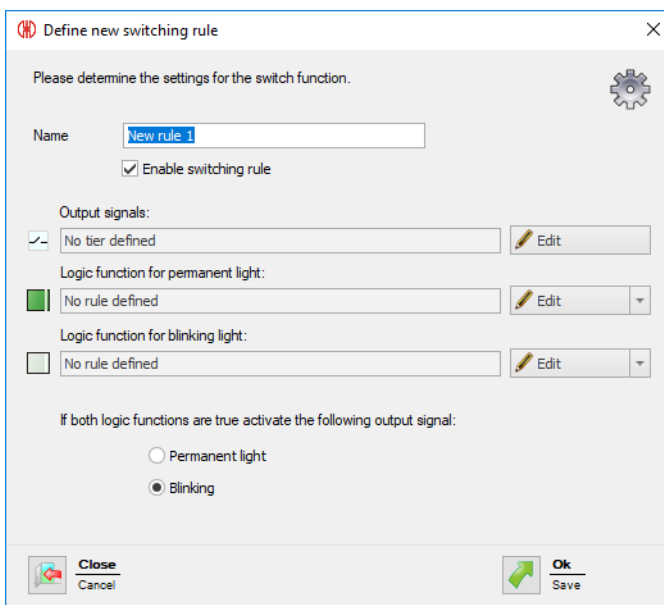

2. In the **Name** field, enter a name for the switching rule.

#### Selecting the output signal

1. Click on **Edit** beside the **Output signals** field.  
→ The **Define new switching rule** window appears and shows an example of a switching rule.

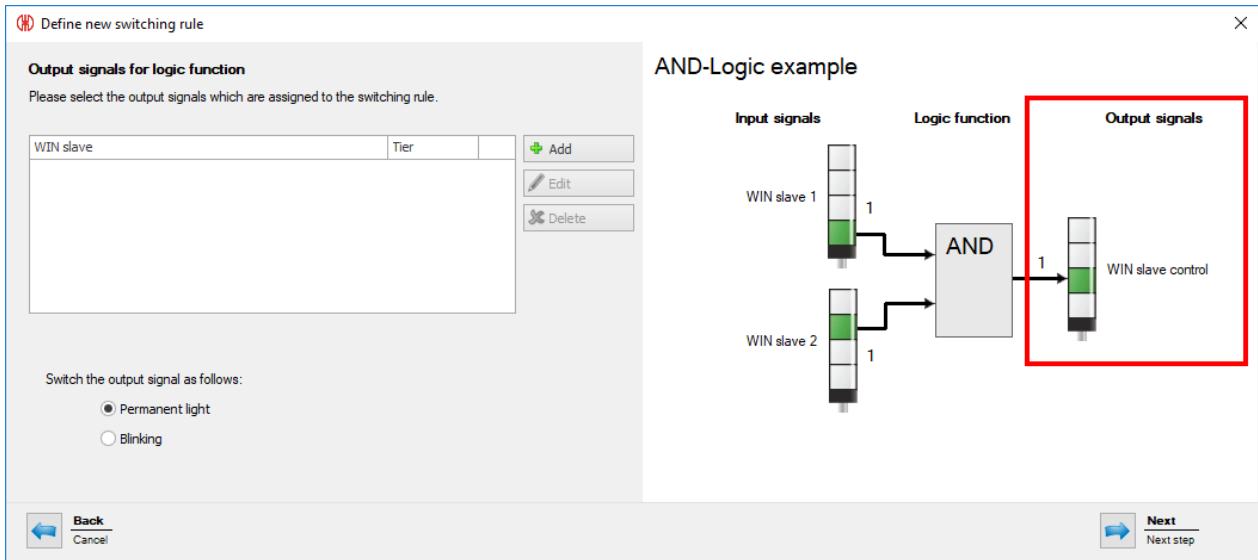

- Click on **Add**.  
→ The **Select tier** window appears.

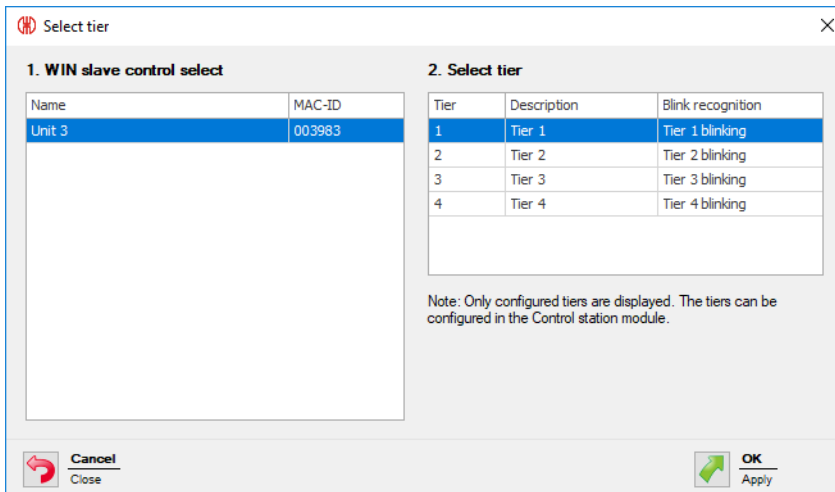

- Select the WIN slave control to be used as the output signal.
- Select the tier to be switched.
- Click **OK** to apply the settings.  
→ The **Define new switching rule** window appears and shows the input signal defined in the list.

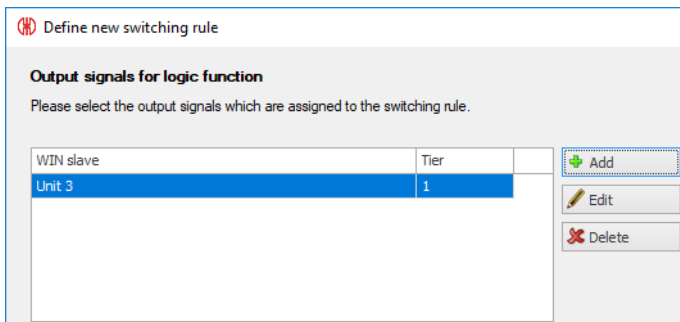

- Click on **Add**, if necessary, to add an additional output signal.



7. Click on **Edit**, if necessary, to modify the selected output signal.
8. Click on **Delete**, if necessary, to delete the selected output signal.
9. Define whether the **Output signal** should be switched as a **Permanent light** or **Blinking**.
10. Click on **Next** to save the settings.  
→ The **Define new switching rule** window appears.

### Selecting the logic function for permanent light

1. Click on **Edit** beside the **Logic function for permanent light** field.  
→ The **Define new switching rule** window appears and shows an example of a switching rule.

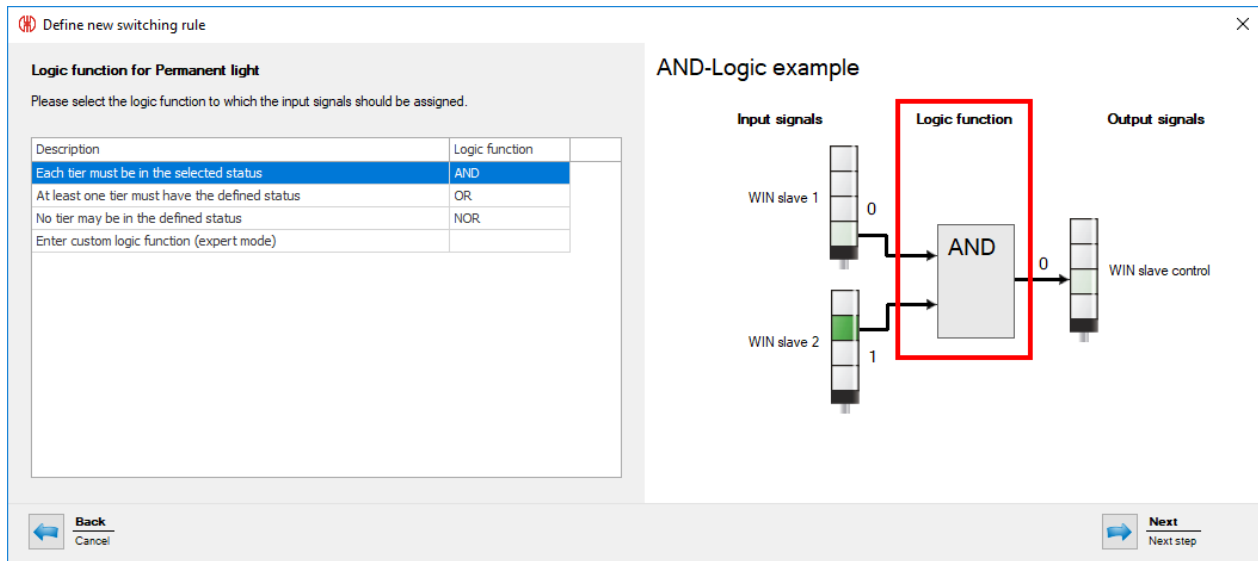

2. Select the **Logic function** with which the input signals are to be linked.

Logic function	Description
AND	Each tier must be in the selected status.
OR	At least one tier must have the selected status.
NOR	No tier may be in the defined status.

- i** The graphic on the right in the window shows an example of the logic function selected. You may wish to create your own *logic functions*.

3. Click on **Next**.  
→ The window to select the input signal appears.

## Selecting the input signal

Define new switching rule
✕

**Input signals for AND-Logic function - Permanent light**

Please select the input signals to be assigned to switching rule AND.

WIN slave	Tier	Status

+ Add
✎ Edit
✖ Delete

**Switching delay**

If a switching delay is set up then the input signals must remain the same for the delay period.

Delay  sec.

← Back  
Cancel
→ Next  
Next step

**AND-Logic example**

- Click on **Add** to select the input signals for the selected logic function.  
→ The **Select tier and status** window appears.

Select tier and status
✕

**1. WIN slave select**

Name	MAC-ID
Unit 1	002705
Unit 2	0027C2
Unit 3	003983

**2. Select tier**

Tier	Description	Blink recognition
1	Operational	-
2	Warning	-
3	Error	-

**3. Select status**

Description
On
Off
Connection error

Note: Only configured tiers are displayed. The tiers can be configured in the Control station module.  
The counter input of a WIN slave performance cannot be used as an input signal.

↶ Cancel  
Close
↷ OK  
Apply

- i** The **Select tier and status** window shows all the WIN slaves included in the WERMA-WIN network. The available tiers and statuses correspond to the tiers and statuses *configured* in the **Control station** module.
- The blinking status is only displayed if blink recognition is enabled for the tier.

- Select the WIN slave to be used as the input signal.
- Select the tier of the WIN slave to be used as the input signal.

- i** The counter input of a WIN slave performance cannot be used as input signal for a logic function.

- Select the status in which the selected tier is to be.

8. Click **OK** to apply the settings.  
→ The **Define new switching rule** window appears and shows the input signal defined in the list.

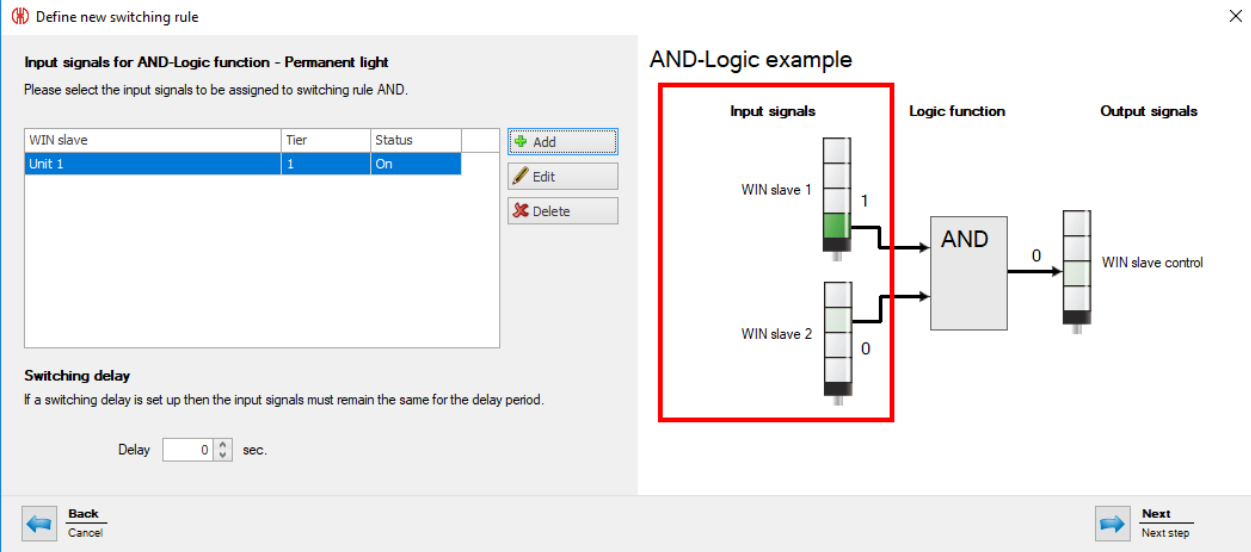

9. Click on **Add**, if necessary, to add an additional input signal.
10. Click on **Edit**, if necessary, to modify the selected input signal.
11. Click on **Delete**, if necessary, to delete the selected input signal.
12. Set the switching delay in the **Delay** field.

---

 The switching delay defines how long all input signals have to be in the same status for the output signal to be switched.

---

13. Click on **Next** to save the settings.  
→ The **Define new switching rule** window appears.

### Selecting the logic function for blinking light

1. Click on **Edit** beside the **Logic function for blinking light** field.  
→ The **Define new switching rule** window appears and shows an example of a switching rule.

Define new switching rule

**Logic function for Blinking**

Please select the logic function to which the input signals should be assigned.

Description	Logic function
Each tier must be in the selected status	AND
At least one tier must have the defined status	OR
No tier may be in the defined status	NOR
Enter custom logic function (expert mode)	

**AND-Logic example**

Input signals: WIN slave 1 (0), WIN slave 2 (0)

Logic function: AND

Output signals: WIN slave control (0)

Back Cancel | Next Next step

2. Select the **Logic function** with which the input signals are to be linked.

Logic function	Description
AND	Each tier must be in the selected status.
OR	At least one tier must have the selected status.
NOR	No tier may be in the defined status.

**i** The graphic on the right in the window shows an example of the logic function selected. You may wish to create your own *logic functions*.

3. Click on **Next**.  
→ The window to select the input signal appears.

### Selecting the input signal

Define new switching rule

**Input signals for AND-Logic function - Blinking**

Please select the input signals to be assigned to switching rule AND.

WIN slave	Tier	Status

+ Add  
Edit  
Delete

**Switching delay**

If a switching delay is set up then the input signals must remain the same for the delay period.

Delay  sec.

**AND-Logic example**

Input signals: WIN slave 1 (1), WIN slave 2 (0)

Logic function: AND

Output signals: WIN slave control (0)

Back Cancel | Next Next step

4. Click on **Add** to select the input signals for the selected logic function.

→ The **Select tier and status** window appears.

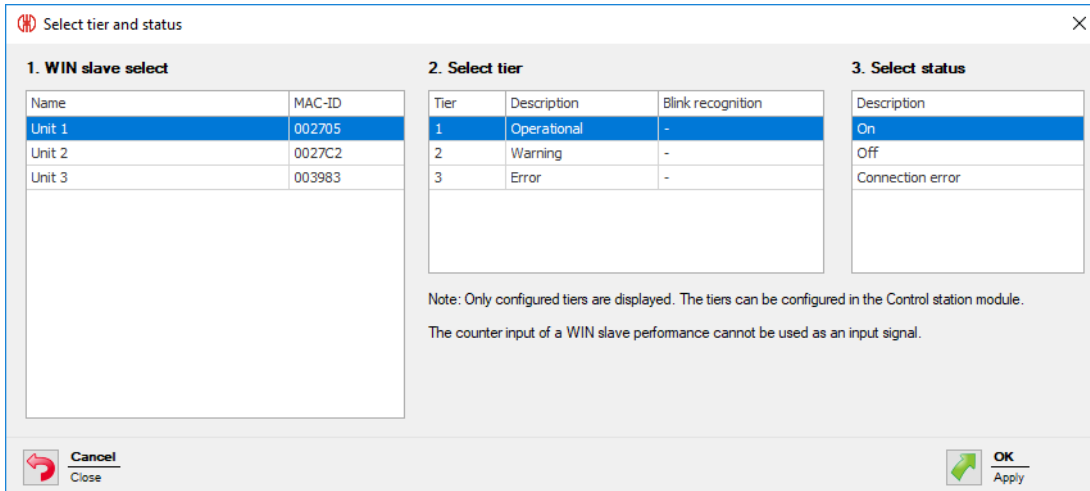

**i** The **Select tier and status** window shows all the WIN slaves included in the WERMA-WIN network. The available tiers and statuses correspond to the tiers and statuses configured in the **Control station** module.

The blinking status is only displayed if blink recognition is enabled for the tier.

5. Select the WIN slave to be used as the input signal.
6. Select the tier of the WIN slave to be used as the input signal.

**i** The counter input of a WIN slave performance cannot be used as input signal for a logic function.

7. Select the status in which the selected tier is to be.
8. Click **OK** to apply the settings.  
→ The **Define new switching rule** window appears and shows the input signal defined in the list.

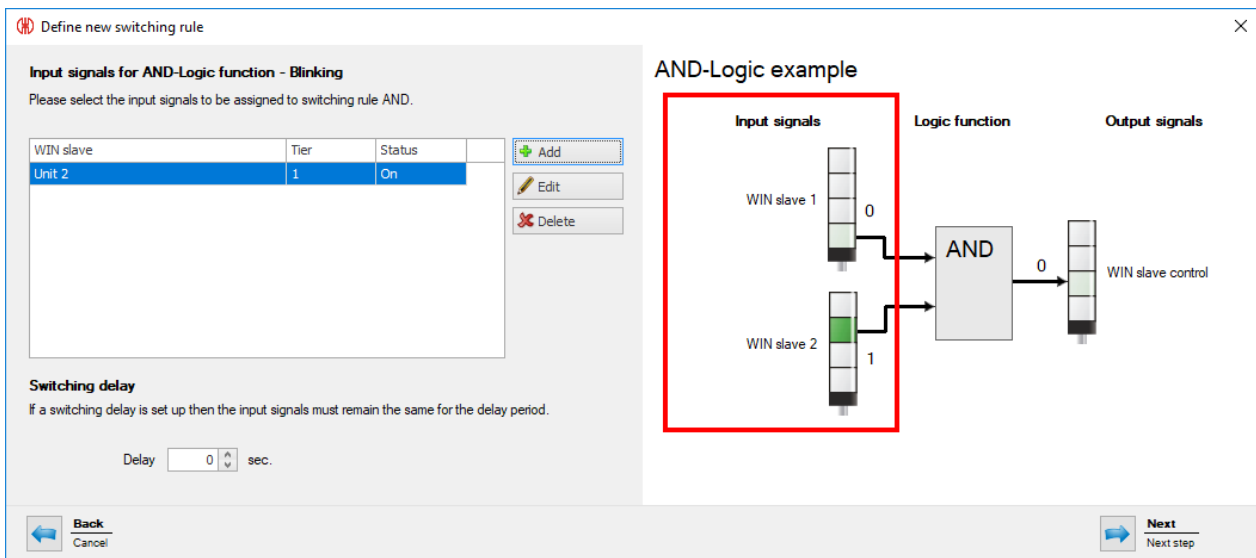

9. Click on **Add**, if necessary, to add an additional input signal.
10. Click on **Edit**, if necessary, to modify the selected input signal.
11. Click on **Delete**, if necessary, to delete the selected input signal.
12. Set the switching delay in the **Delay** field.

**i** The switching delay defines how long all input signals have to be in the same status for the output signal to be switched.

13. Click on **Next** to save the settings.  
→ The **Define new switching rule** window appears.
14. Select whether the output signal should be switched as a **Permanent light** or **Blinking**, if both logic functions apply.
15. Click on **OK** to save the switching rule.  
→ The switching rule appears in the rule overview and is enabled.

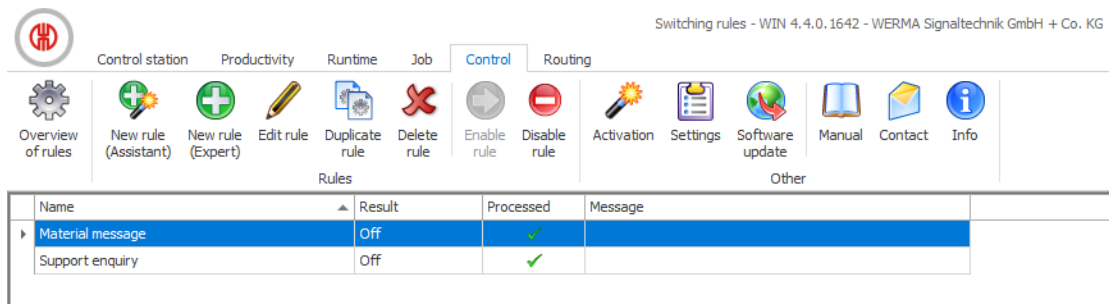

### 3.5.2.3 Entering custom logic function in expert mode

1. Select **Enter custom logic function (expert mode)** option in the **Switching rule** window.
2. Click on **Next**.  
→ The **Logic function (expert mode)** window appears.

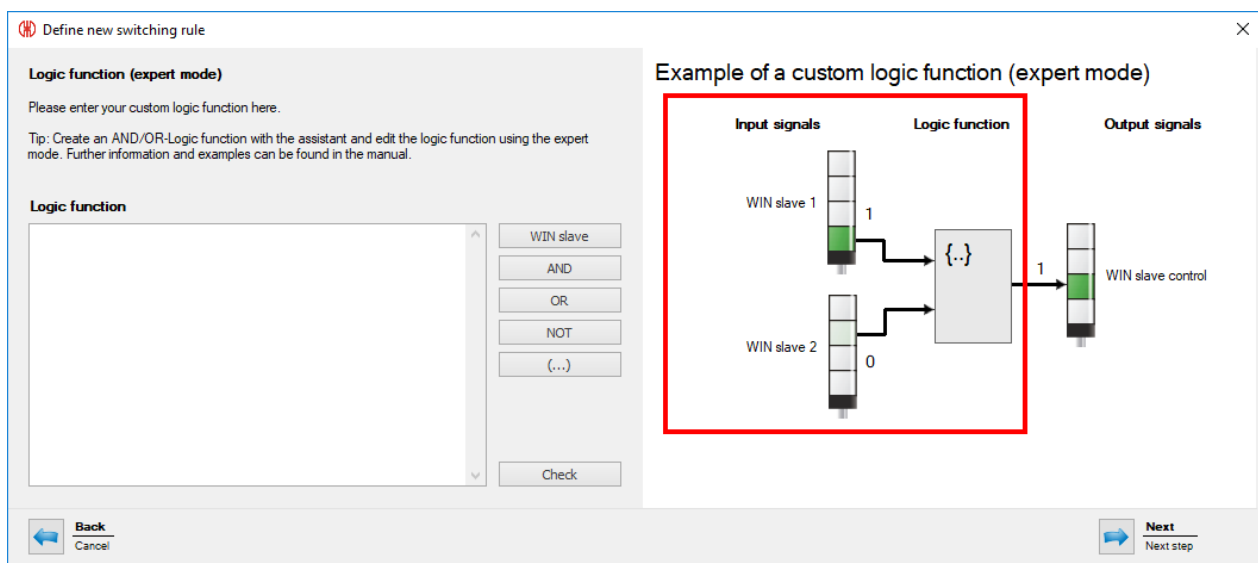

3. Enter a custom logic function in Visual Basic Syntax or create it using the buttons in the **Logic function** area.

Button	Function
<b>WIN slave</b>	Paste tier and status of a WIN slave.
<b>AND</b>	Paste logic function AND.
<b>OR</b>	Paste logic function OR.
<b>NOT</b>	Paste logic function NOT.
<b>(...)</b>	Paste brackets.

-  The program code uses the MAC IDs of the WIN slaves, not the individual WIN slave names.

4. Click on **Check** to check the switching rule created.  
 → WERMA-WIN checks the switching rule.  
 → If the switching rule includes errors, a window appears with relevant information on resolving the errors.
5. Click on **Next**.  
 → The switching rule is saved.

## Examples of custom logic functions

### Example 1: AND rule

Tier 1 and Tier 2 of a WIN slave must have the status **ON**.

```
Slave("0024B1").Tier1.On AND Slave("0024B1").Tier2.On
```

### Example 2: OR rule

Tier 1 of a WIN slave must have the status **Blinking** or Tier 2 of the same WIN slave must have the status **OFF**.

```
Slave("0024B1").Tier1.Blink OR Slave("0024B1").Tier2.Off
```

### Example 3: NOR rule

Neither of the two WIN slave may display a connection error.

```
NOT (Slave("0024B1").Tier1.Error OR Slave("0024B2").Tier1.Error)
```

### Example 4: Logic function using variables

```
' declare variables
Dim a As Boolean
Dim b As Boolean
Dim x As Boolean

' read out Slave statuses and store in variables
a = Slave("0024A1").Tier1.On
b = Slave("0024A2").Tier1.On
```

```
' Program code which processes variables.
```

```
x = a OR b
```

```
' Note: if multiple program lines are entered,
```

```
' the result of the logic function must be returned as Boolean data type with  
' 'Return'.
```

```
Return x
```

### 3.5.3 Enabling a rule

1. Select the switching rule in the rule overview.
2. Click on **Enable rule** in the toolbar.
3. Confirm the prompt with **Yes** to enable the rule.

### 3.5.4 Disabling a rule



The WIN slave control remains in the last transmitted status as soon as a switching rule has been disabled.

---

1. Select the switching rule in the rule overview.
2. Click on **Disable rule** in the toolbar.
3. Confirm the prompt with **Yes** to disable the switching rule.

### 3.5.5 Editing a rule

1. Select the switching rule in the rule overview.
2. Click on **Edit rule** in the toolbar.  
→ The **Edit switching rule** window appears.



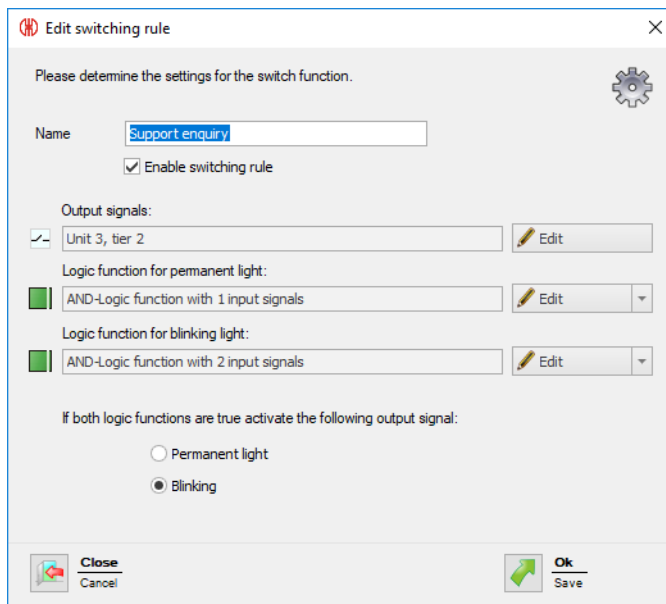

3. Enable or disable **Enable switching rule** to immediately enable or disable the switching rule.
4. Adapt the **Output signals** by clicking on **Edit**, if necessary.

---

i Only one switching rule can be enabled on an output signal.

---

5. Adapt the **Logic function for permanent light** and the **Logic function for blinking light**: by clicking on **Edit**, if necessary.
6. Remove the **Logic function for permanent light** and the **Logic function for blinking light** by expanding the **Edit** button and clicking on **Delete**, if necessary.
7. Select whether the output signal should be switched as a **Permanent light** or **Blinking**, if both logic functions apply.
8. Click **OK** to apply the settings.

### 3.5.6 Duplicating a rule

1. Select the switching rule in the rule overview.
2. Click on **Duplicate rule** in the toolbar.
3. Confirm the prompt with **Yes**.  
→ The **Duplicate switching rule** window appears.

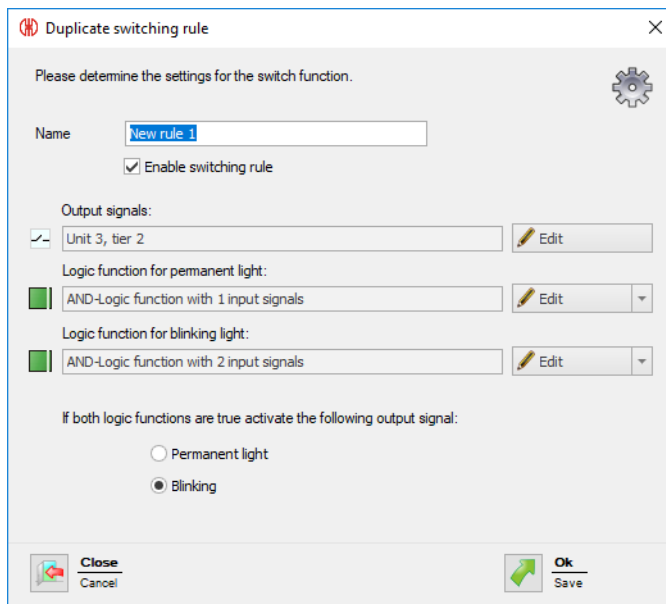

4. Enter the name of the switching rule in the **Name** field.
5. Enable or disable **Enable switching rule** to immediately enable or disable the switching rule.
6. Adapt the **Output signals** by clicking on **Edit**, if necessary.

---

 Only one switching rule can be enabled on an output signal.

---

7. Adapt the **Logic function for permanent light** and the **Logic function for blinking light**: by clicking on **Edit**, if necessary.
8. Remove the **Logic function for permanent light** and the **Logic function for blinking light** by expanding the **Edit** button and clicking on **Delete**, if necessary.
9. Select whether the output signal should be switched as a **Permanent light** or **Blinking**, if both logic functions apply.
10. Click **OK** to apply the settings.

### 3.5.7 Deleting a rule

---

 The WIN slave control remains in the last transmitted status once a switching rule has been deleted.





---

1. Select the switching rule in the rule overview.
2. Click on **Delete rule** in the toolbar.
3. Confirm the prompt with **Yes** to delete the rule.

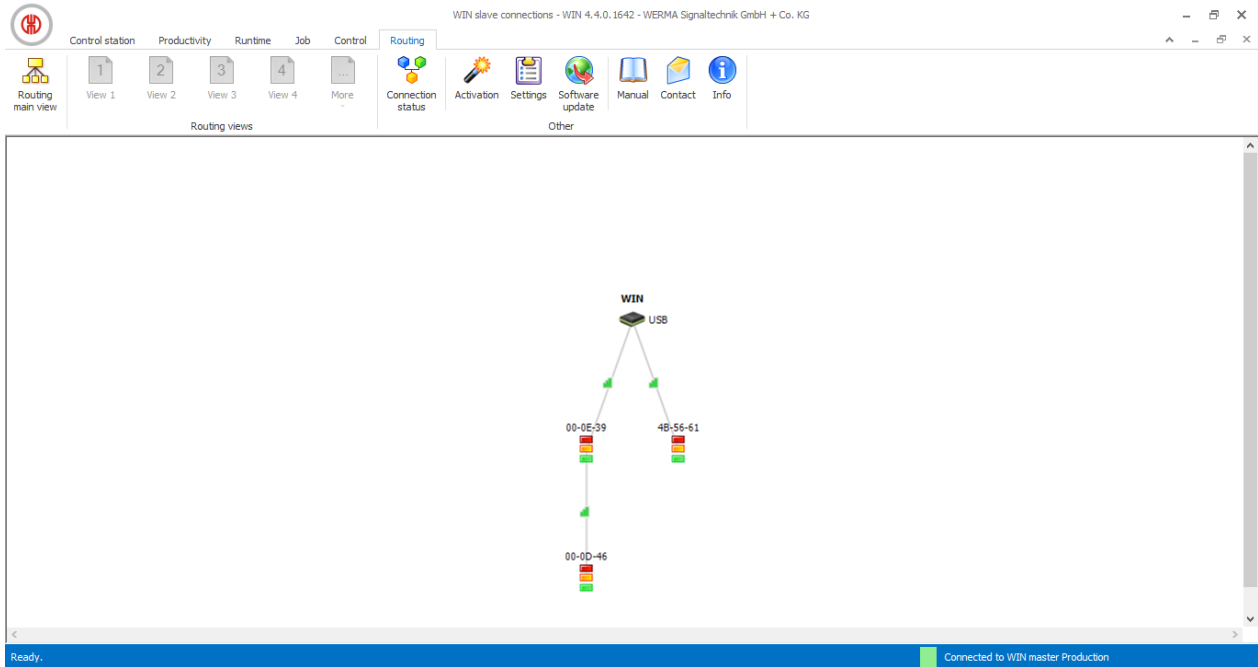
### 3.6 Routing

The **Routing** module shows an overview of the WERMA-WIN network. A tree structure shows the structure and the quality of the wireless connections between the individual devices.



Design	Description
	WIN master
	WIN ethernet master
	WIN slave, WIN slave control, WIN slave performance
	Good radio connection between the devices.
	Weak radio connection between the devices.

Design	Description
	Poor radio connection between the devices.

To ensure the best possible radio connection, every WIN slave automatically looks for the best transmission path to the WIN master. Other WIN slave can act as repeaters and forward the radio signal to improve the radio connection or increase the range.

Direct connection:

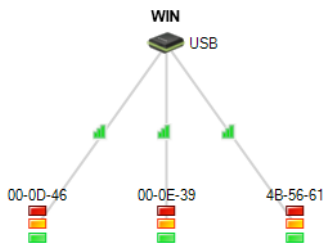

Connection via another WIN slave as a repeater:

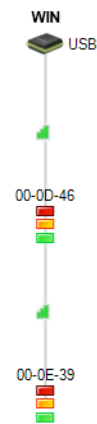

**i** A WIN slave can set up a connection to the WIN master via at most two more WIN slaves.

**i** Unconnected but configured WIN slaves are displayed in the lower part of the window, if there are any.

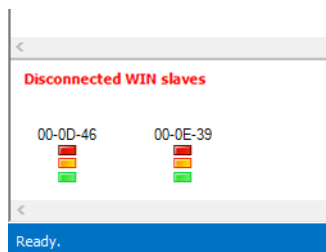

### 3.6.1 Displaying connection status

The connection status and the connection type of all WIN masters saved in the WERMA-WIN database can be displayed in the **Connection status** window.

1. Click on **Connection status** in the toolbar.  
→ The **Connection status** window appears.

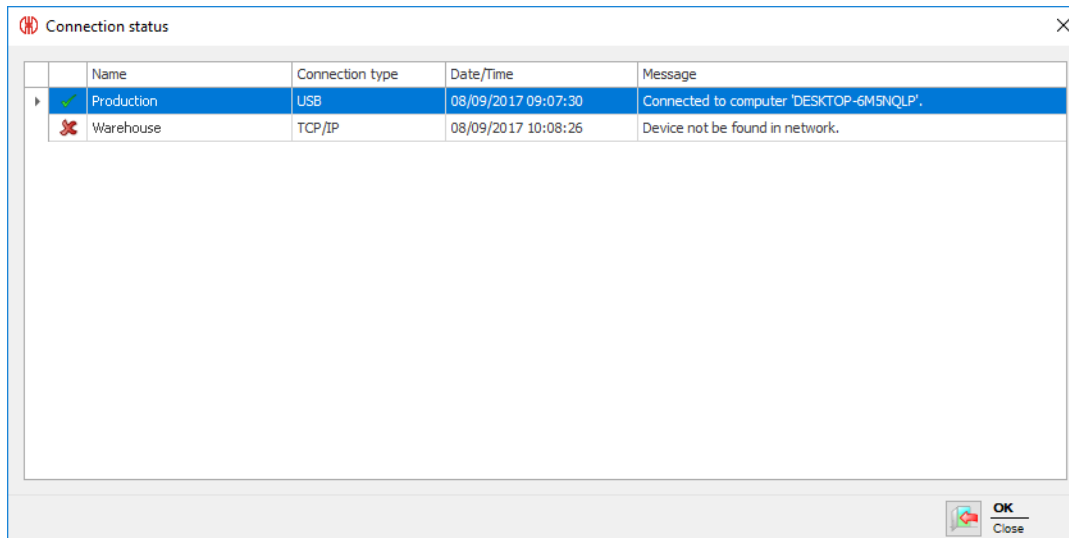

### 3.6.2 Optimising wireless communication

Wireless communication can be improved by implementing the following measures:

- Position the WERMA-WIN devices within sight of each other.
- Remove as many metal surfaces as possible between the WERMA-WIN devices.
- Position WIN master as ideally as possible.
- Poor radio connections can be improved by the use of a repeater (WIN slave).
- Connect any parts of the system outside of radio range via a further WIN master.

## 3.7 Settings

The functions of WERMA-WIN can be modified under Settings.

- 
-  Settings can be *protected* by a password to prevent unauthorised access.
- 

To call up Settings:

1. Click **Settings** in the toolbar.  
→ The **Settings** window appears.

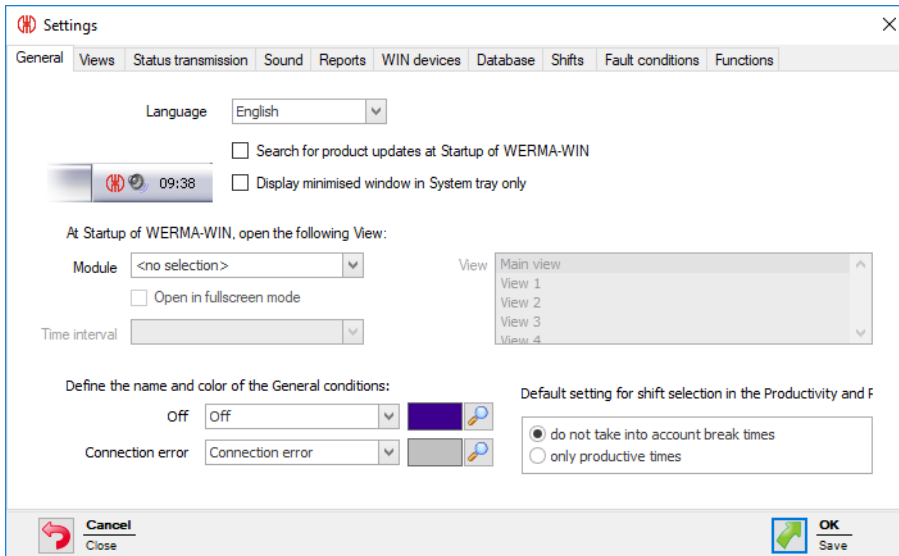

### 3.7.1 General

Various settings can be modified on the **General** tab.

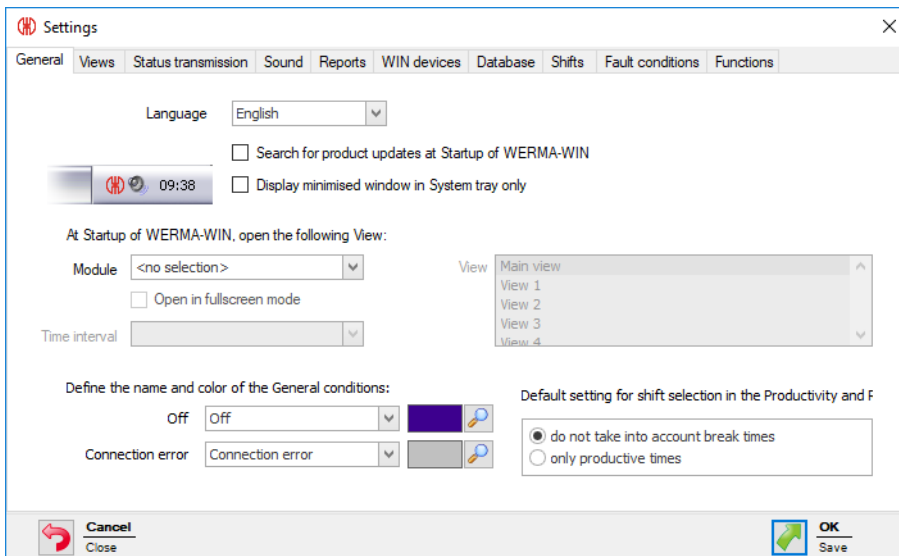

The following settings can be modified:

- Program interface language
- Search for updates
- Minimise program window in the system tray
- View at program start
- Description and colour of general statuses
- Standard setting for shift selection

#### 3.7.1.1 Selecting the language of the program interface

1. Select the language in the **Language** dropdown list.

- Click on **OK** to save the settings.  
→ WERMA-WIN is restarted and appears in the selected language after the restart.

### 3.7.1.2 View at program start

It is possible to set which module is to be automatically displayed in which view when the program starts.

The following views are possible:

Module	Main view	More views	Time interval	Full screen mode
Control station	✓	✓		✓
Productivity	✓	✓	✓	✓
Runtime	✓	✓	✓	
Job	✓			
Control	✓			
Routing	✓			

- Select the desired module in the **Module** selection list.
- Select the required view in the **View** list.
- If the **Runtime** or **Productivity** module has been selected, select the required time interval in the **Time interval** selection list.
- Enable **Open in fullscreen mode** if WERMA-WIN is to be started in full-screen mode.
- Click on **OK** to save the settings.

### 3.7.1.3 Minimising program window in the system tray

The minimised WERMA-WIN program window can be displayed in the taskbar (Windows standard) or in the system tray.

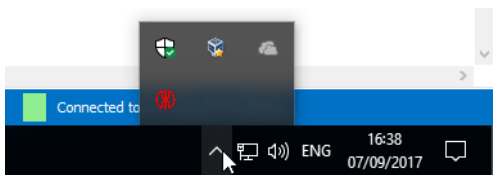

To display the minimised WERMA-WIN program window in the system tray.

- Enable **Display minimised window only in the system tray**.
- Click on **OK** to save the settings.

### 3.7.1.4 Updates

WERMA-WIN can search for updates after every program startup.

- Enable **Search for product updates at Startup of WERMA-WIN**.
- Click on **OK** to save the settings.



The computer must be connected to the internet and must be able to access www.wer-ma.com to search for updates.

### 3.7.1.5 General statuses

The descriptions and colours of the general statuses **Off** and **Connection error** can be adapted individually.

Define the name and color of the General conditions:

Off	<input type="text" value="Off"/>	
Connection error	<input type="text" value="Connection error"/>	

1. Select one of the default texts in the Off or Connection error selection list or enter an individual text.
2. Click on **Select colour** and define the required colour.
3. Click on **OK** to save the settings.

### 3.7.1.6 Shift selection default setting

The setting in the **Shift** filter can be set as a default system-wide for the **Runtime** and **Productivity** modules.

Default setting for shift selection in the Productivity and F

<input checked="" type="radio"/> do not take into account break times
<input type="radio"/> only productive times

1. Select the required option.
2. Click on **OK** to save the settings.  
→ The selected setting is used as the default in the Shift filter in the **Runtime** and **Productivity** modules.

Time interval	<input type="text" value="Last hour"/>
Shift	<input type="text" value="do not take into account break ti..."/>

## 3.7.2 Views

The views of the **Control station**, **Productivity** and **Runtime** modules can be created and adapted in the **Views** tab.



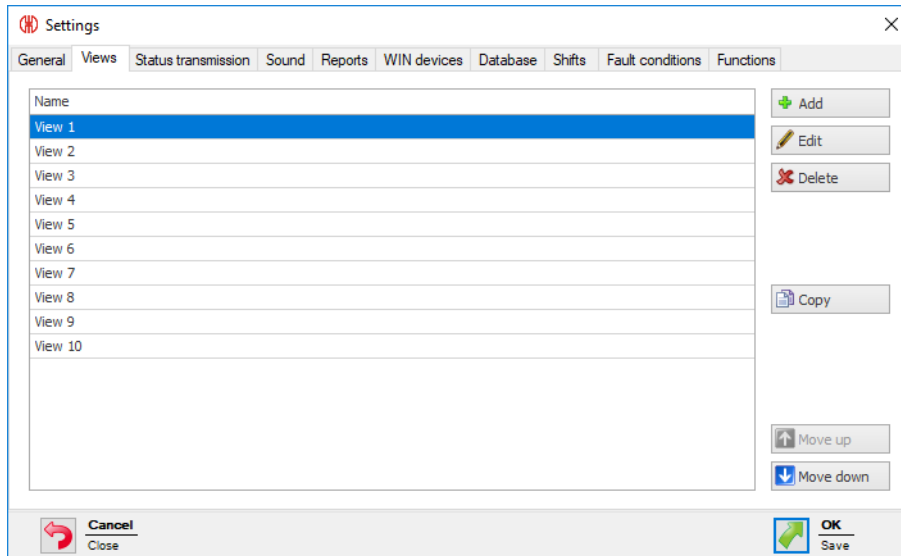

The following functions are possible:

- Add views
- Copy views
- Rename views
- Sort views
- Delete views

### 3.7.2.1 Adding a view

1. Click on **Add**.  
→ The **Create view** window appears.

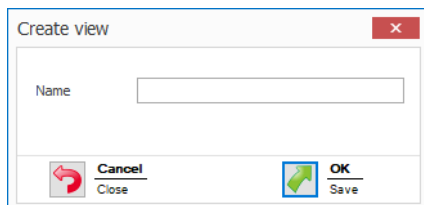

2. Enter the name of the view in the **Name** field.

---

**i** If the name of the view contains a &, then it must be entered as &&. The name Warehouse 1 & Warehouse 2, for example, must be entered as Warehouse 1 && Warehouse 2.

---

3. Click on **OK** to add the view.

### 3.7.2.2 Copying views

1. In the list of views, select the view to be copied.
2. Click on **Copy**.  
→ The **Copy view** window appears.

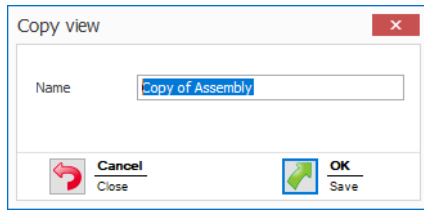

3. In the **Name** field, adapt the name of the view.
4. Click on **OK** to copy the view.

### 3.7.2.3 Renaming views

1. In the list of views, select the desired view.
2. Click on **Edit**.  
→ The **Edit view** window appears.

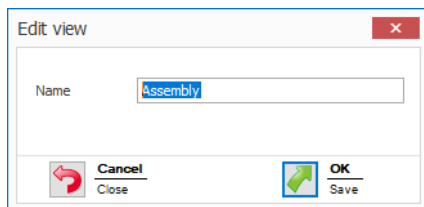

3. In the **Name** field, adapt the name of the view.



If the name of the view contains a &, then it must be entered as &&. The name Warehouse 1 & Warehouse 2, for example, must be entered as Warehouse 1 && Warehouse 2.

---

4. Click on **OK** to save the setting.

### 3.7.2.4 Sorting views

You can adapt the order of the views in the toolbar.

1. In the list of views, select the desired view.
2. Click **Move up** or **Move down** to move the view.



Views arranged at the top of the list of view appear first in the toolbar.

---

### 3.7.2.5 Deleting views

1. In the list of views, select the view to be deleted .
2. Click **Delete**.
3. Confirm the prompt with **Yes**.

### 3.7.3 Status transmission

A *status transmission* can be enabled by e-mail for individual WIN slaves in the **Control station** module. The necessary settings can be modified in the **Status transmission** tab. The transfer of the status transmission to an external program using *WINtoApplication* can also be configured.

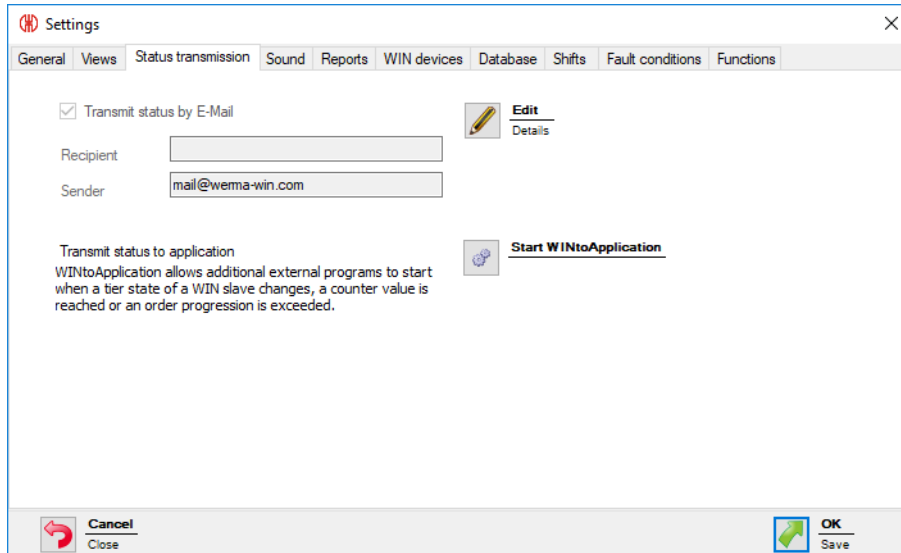

The following settings are possible:

- *Disable e-mail transmission*
- *Modify settings of integrated e-mail transmission function*
- *Configure own SMTP server for the transmission of e-mails*
- *Modify message texts*
- *Configure WINtoApplication*

#### 3.7.3.1 Disabling e-mail transmission

1. Click on **Edit**.  
→ The **E-mail settings** window appears.

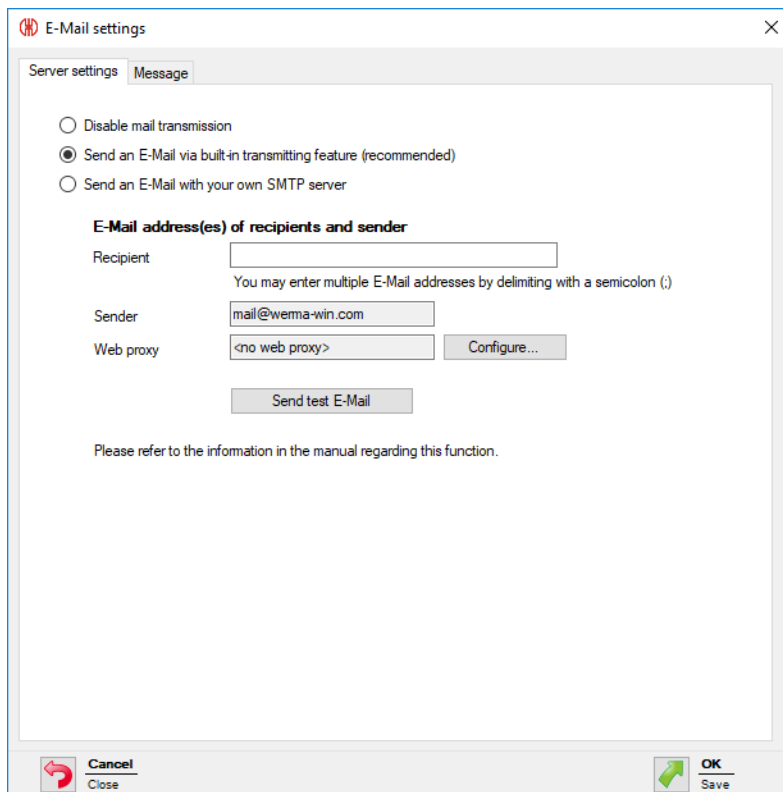

2. Select **Disable mail transmission** option.
3. Click on **OK** to save the setting.

### 3.7.3.2 Integrated transmission function

The e-mail transmission function integrated in WERMA-WIN is restricted as follows:

- Max. 10 recipients per e-mail
- Max. 100 different recipients in seven days
- Max. 240 e-mails in 4 hours

---

**i** If more than 240 e-mails are sent in 4 hours, then message delivery is interrupted for one hour. The messages that accumulate during the interruption are not subsequently sent.

Transmission using your own *SMTP* server is recommended if the transmission function is to be used beyond these limits.

---

1. Click on **Edit**.  
→ The **E-Mail settings** window appears.

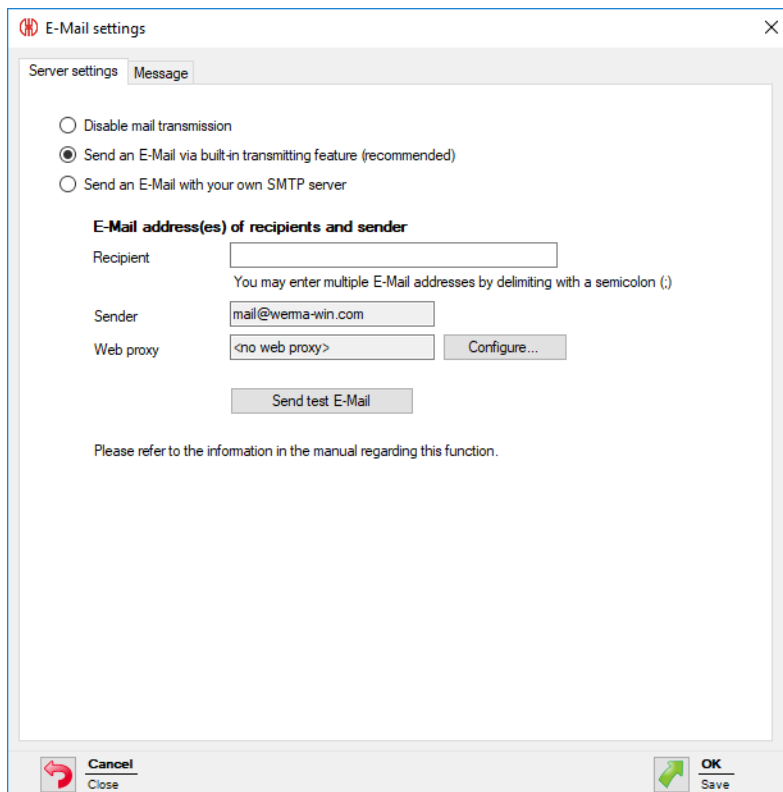

2. Select **Send an e-mail via built-in transmitting feature (recommended)** option.

3. Enter e-mail recipients in the **Recipient** field.

---

**i** Multiple recipients are separated by a semicolon (;).

---

**i** If no e-mail recipient is specified, the recipient must be specified when *enabling status transmission* for the respective WIN slave.

4. Adapt the **Web proxy** by clicking on **Configure...** if necessary.

---

**i** Clicking on **Send test E-Mail** sends a test e-mail to test the settings entered.

5. Click on **OK** to save the settings.

### Configuring the web proxy

If a web proxy is used in the network, the access data can be entered in the **Configuration of web proxy** window.

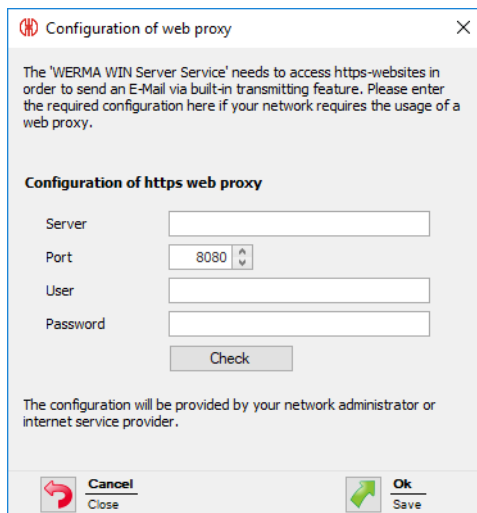

1. Enter access data into the respective fields.

---

 Your network administrator will provide the requisite data.

---

2. Click on **Check**.  
→ WERMA-WIN checks the entered data.
3. Click on **OK** to save the settings.

### 3.7.3.3 Custom SMTP server

1. Click on **Edit**.  
→ The **E-mail settings** window appears.

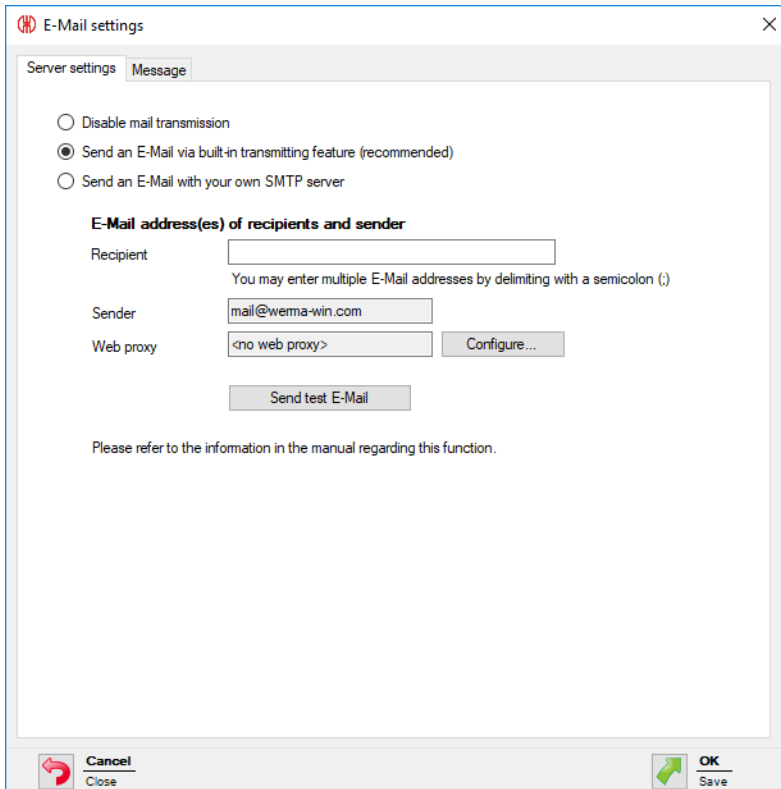

**E-Mail settings**

Server settings | Message

Disable mail transmission  
 Send an E-Mail via built-in transmitting feature (recommended)  
 Send an E-Mail with your own SMTP server

**E-Mail address(es) of recipients and sender**

Recipient:   
You may enter multiple E-Mail addresses by delimiting with a semicolon (;)

Sender:

Web proxy:

Please refer to the information in the manual regarding this function.

2. Select **Send an e-mail with your own SMTP server** option.  
 → The fields to adapt your custom SMTP server appear.

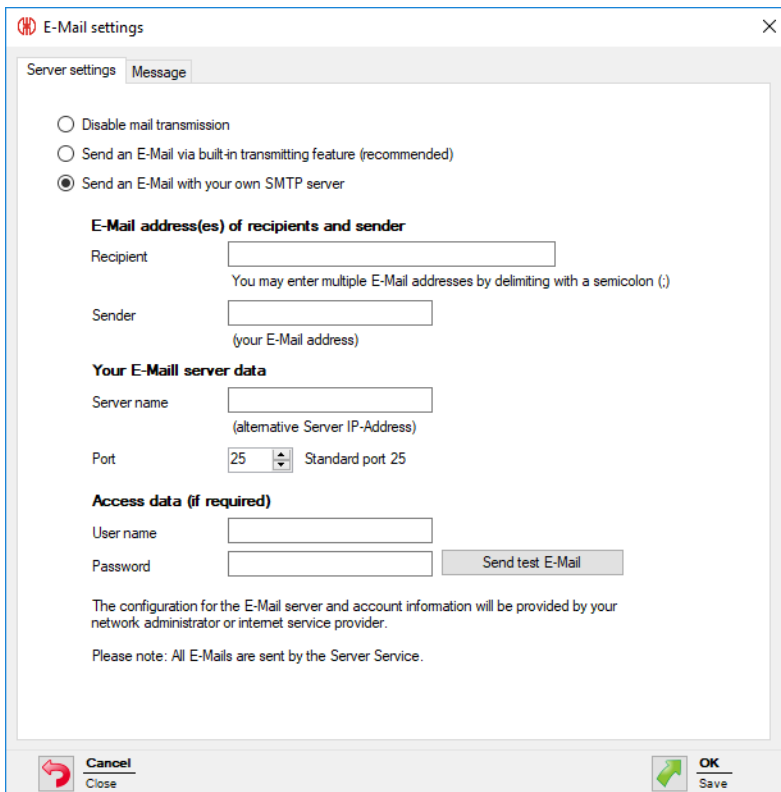

**E-Mail settings**

Server settings | Message

Disable mail transmission  
 Send an E-Mail via built-in transmitting feature (recommended)  
 Send an E-Mail with your own SMTP server

**E-Mail address(es) of recipients and sender**

Recipient:   
You may enter multiple E-Mail addresses by delimiting with a semicolon (;)

Sender:   
(your E-Mail address)

**Your E-Mail server data**

Server name:   
(alternative Server IP-Address)

Port:  Standard port 25

**Access data (if required)**

User name:

Password:

The configuration for the E-Mail server and account information will be provided by your network administrator or internet service provider.

Please note: All E-Mails are sent by the Server Service.

3. Enter e-mail recipients in the **Recipient** field.

---

 Multiple recipients are separated by a semicolon (;).

---

4. Enter the sender address in the **Sender** field.

5. Enter the details of your SMTP server in the respective fields in the **Your E-Mail server data** and **Access data (if required)** areas.

---

 Your network administrator or internet provider can provide the requisite data.

---

 Clicking on **Send test E-Mail** sends a test e-mail to test the settings entered.

---

6. Click on **OK** to save the settings.

### 3.7.3.4 Modifying message texts

The subject and the text of the e-mail can be modified by pasting individual texts and different placeholders.

1. Call up the **Message** tab.

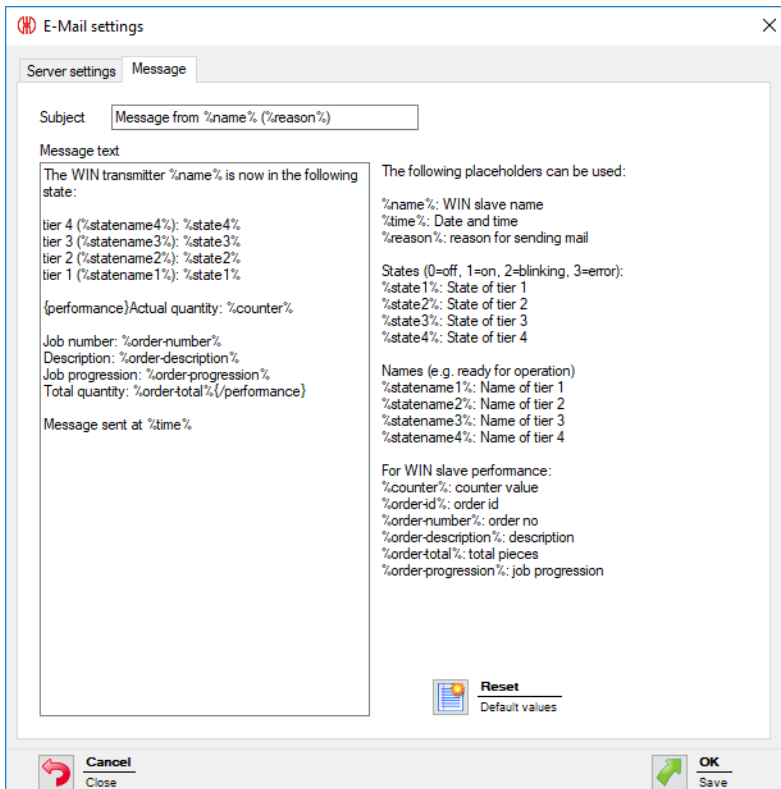

The screenshot shows the 'E-Mail settings' dialog box with the 'Message' tab selected. The 'Subject' field contains the text 'Message from %name% (%reason%)'. The 'Message text' field contains the following text:

The WIN transmitter %name% is now in the following state:

tier 4 (%statename4%): %state4%  
tier 3 (%statename3%): %state3%  
tier 2 (%statename2%): %state2%  
tier 1 (%statename1%): %state1%

{performance}Actual quantity: %counter%

Job number: %order-number%  
Description: %order-description%  
Job progression: %order-progression%  
Total quantity: %order-total%/{performance}

Message sent at %time%

The following placeholders can be used:

%name%: WIN slave name  
%time%: Date and time  
%reason%: reason for sending mail

States (0=off, 1=on, 2=blinking, 3=error):  
%state1%: State of tier 1  
%state2%: State of tier 2  
%state3%: State of tier 3  
%state4%: State of tier 4

Names (e.g. ready for operation)  
%statename1%: Name of tier 1  
%statename2%: Name of tier 2  
%statename3%: Name of tier 3  
%statename4%: Name of tier 4

For WIN slave performance:  
%counter%: counter value  
%order-id%: order id  
%order-number%: order no  
%order-description%: description  
%order-total%: total pieces  
%order-progression%: job progression

At the bottom right of the message text area, there is a 'Reset' button with a small icon and the text 'Default values'. At the bottom of the dialog box, there are 'Cancel' and 'OK' buttons.

2. Enter the text and *placeholders* required in the **Subject** and **Message** fields.



---

 Clicking on **Reset** resets the subject and the message text to the default values.

---

3. Click on **OK** to save the setting.

### Example of a message text:

The WIN slave %name% changed its status at %time%.

Tier 4 (%statename4%): %state4%

Tier 3 (%statename3%): %state3%

Tier 2 (%statename2%): %state2%

Tier 1 (%statename1%): %state1%

### Placeholders/Parameters

The following placeholders/parameters are available:

Placeholders/Parameters	Description
%slaveid%	ID of the WIN slave
%name%	Description of the WIN slave
%time%	Date and time of status transmission
%reason%	Reason for status transmission
%state1%	Status of tier 1
%state2%	Status of tier 2
%state3%	Status of tier 3
%state4%	Status of tier 4
%statename1%	Description of tier 1
%statename2%	Description of tier 2
%statename3%	Description of tier 3
%statename4%	Description of tier 4
%counter%	Counter status of the job
%order-id%	Job ID
%order-number%	Job number
%order-description%	Description of job
%order-total%	Total amount of job
%order-progression%	Job progression

---

 All placeholders/parameters start and end with the character %.

---

## 3.7.4 Sound

Status change messages can be indicated by playing an individual signal tone.

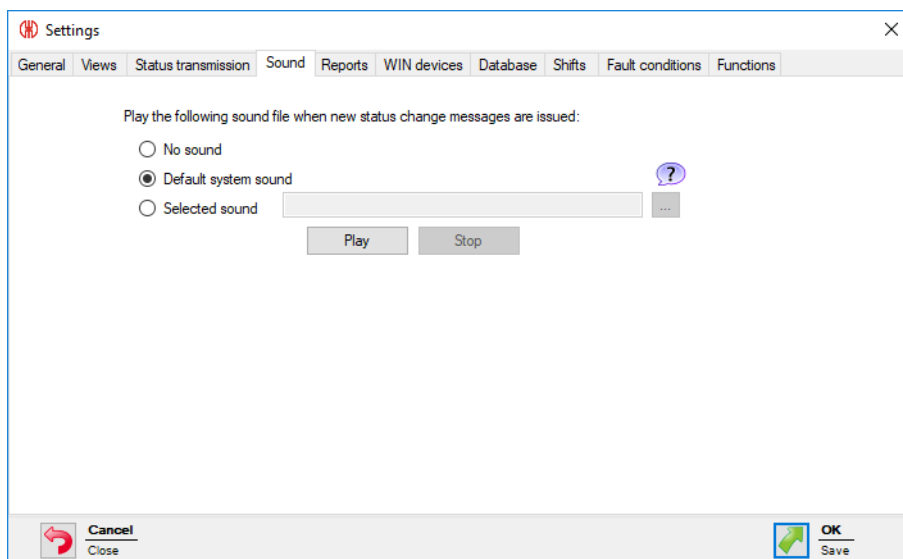

---

**i** WERMA-WIN offers a pre-selection of signalling sounds. An overview of the pre-selection is displayed by clicking on **?**.

---

1. Select which sound is to be played when a status change message appears.
  2. Select the **Selected sound** option and click on **Browse** **...** to play an individual sound.
  3. Select the file in the appropriate format and click on **Open**.
- 

**i** Files in the popular audio formats (.mp3, .wav etc.) can be used.

---

**i** The selected sound can be tested by clicking on **Play** and **Stop**.

---

4. Click on **OK** to save the settings.

### 3.7.5 Reports

Individual headers and footers can be saved for reports.



1. In the **Company name** field, enter the text for the footer.
2. Click **Select** to paste an individual company logo into the header.

---

 Graphics in the popular graphic formats (.jpg, .png etc.) can be used.  
The graphic file may not exceed 1 MB. The height and width are each restricted to 2,000 pixels.

---

 Clicking **Reset** resets all settings to the default settings (WERMA logo and WERMA company name).

---

3. Click on **OK** to save the settings.

### 3.7.6 WIN devices

WERMA-WIN devices which are no longer in the WERMA-WIN network can be deleted. All data recorded by these devices will be deleted from the WERMA-WIN database.

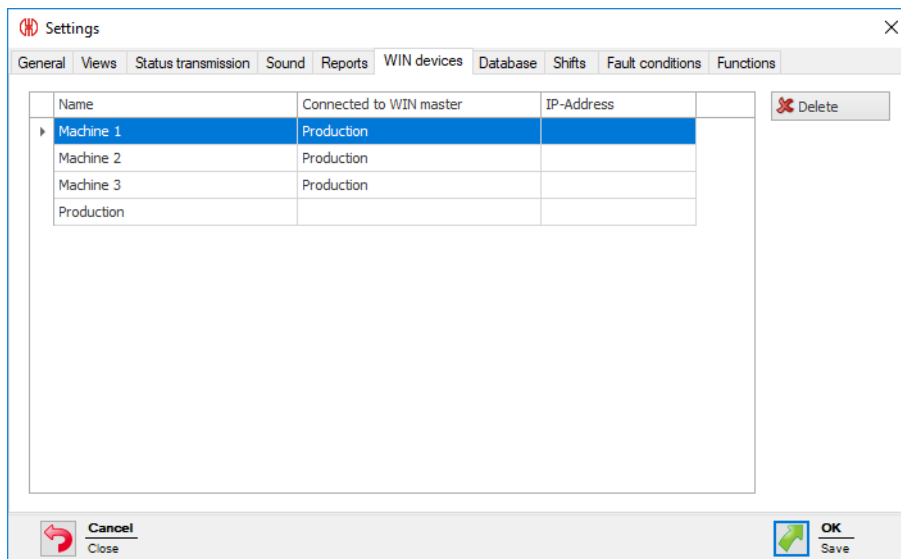

- 
- WIN masters can only be deleted if the power supply to the WIN master is disconnected.  
WIN slaves can only be deleted if the power supply to the WIN slave is disconnected.
- 

1. In the list of WERMA-WIN devices, select the WERMA-WIN device to be deleted.

---

- Several WERMA-WIN devices can be selected by pressing CTRL.
- 

2. Click **Delete**.  
3. Confirm the prompt with **Yes**.

### 3.7.7 Database

Various settings of the WERMA-WIN database can be adapted and the device data backed up or imported in the **Database** tab.

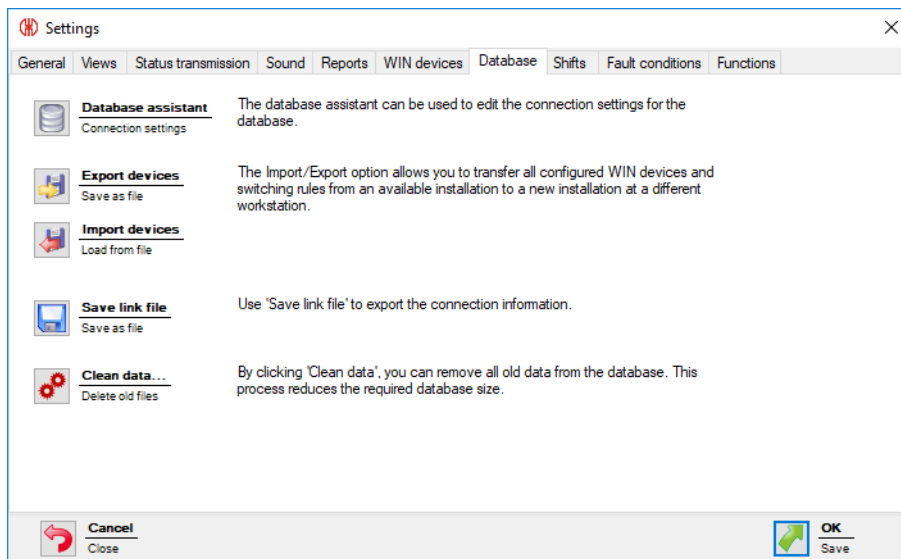

The following functions are available:

- Adapt connection settings in the *Database assistant*
- *Export devices*
- *Import devices*
- *Create link file*
- *Clean old data*

### 3.7.7.1 Database assistant

The database assistant can be used to edit the connection settings for the database.

---

 Administrator rights are needed to install Database assistant.

---

1. Click on **Database assistant**.
2. Confirm the prompt with **Yes**.  
→ WERMA-WIN is completed and the assistant appears to set up the database.

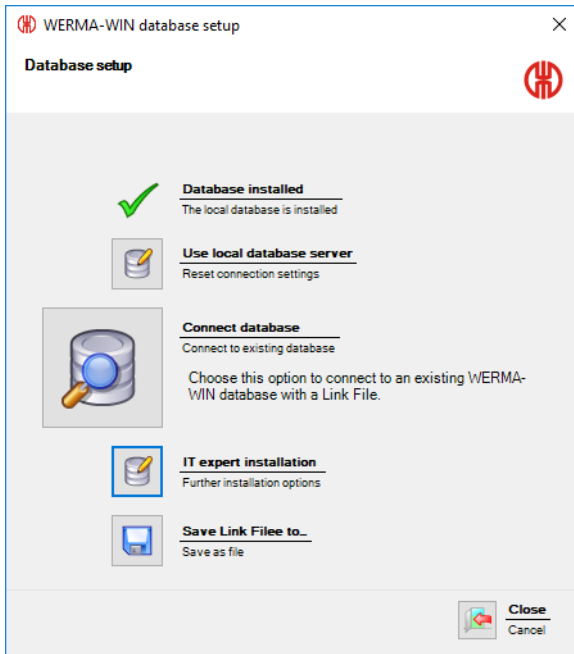

The wizard to set up the database offers the following functions:

Function	Description
<b>Use local database server</b>	Reset existing connection settings.
<b>Connect database</b>	Connect to an existing WERMA-WIN database and thus enable multi-user access to the database.
<b>IT expert installation</b>	Enable <i>Expert installation</i> and adapt the saved connection settings.
<b>Save Link File to...</b>	Save the link file to connect other workplaces to the WERMA-WIN database.

### 3.7.7.2 Exporting devices

All device configurations and switching rules can be exported to apply all configured WERMA-WIN devices from an existing installation to a new installation or to another workplace.

1. Click on **Export devices**.
2. Select the filename and storage location for the export file.
3. Click on **Save**.

### 3.7.7.3 Importing devices

---

 During import, all existing device configurations and switching rules are overwritten.

---

1. Click on **Import devices**.
2. Select the saved export file.
3. Click on **Open**.

4. Confirm the prompt with **Yes**.

### 3.7.7.4 Creating a link file

The link file lets you connect other WERMA-WIN installations on other workplaces to the WERMA-WIN database.

1. Click on **Save link file**.
2. Select the file location for the link file.

### 3.7.7.5 Cleaning data

Old data can be removed and deleted from the WERMA-WIN database. You can specify from what point in time the data is to be kept.

1. Click on **Clean data...**  
→ The **Data Removal** window appears.

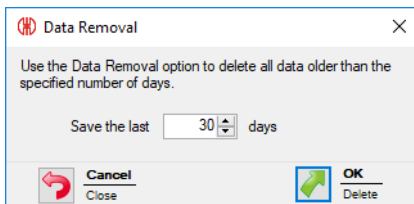

2. Select the time interval from when the data is to be kept.
3. Click on **OK**.
4. Confirm the prompt with **Yes**.

## 3.7.8 Shifts

Shifts can be created and assigned to the individual WIN slave for analysis in the **Runtime** and **Productivity** modules.

Different time periods and pause times can be combined in a shift. The time periods can be entered differently for each day of the week and span more than one day.

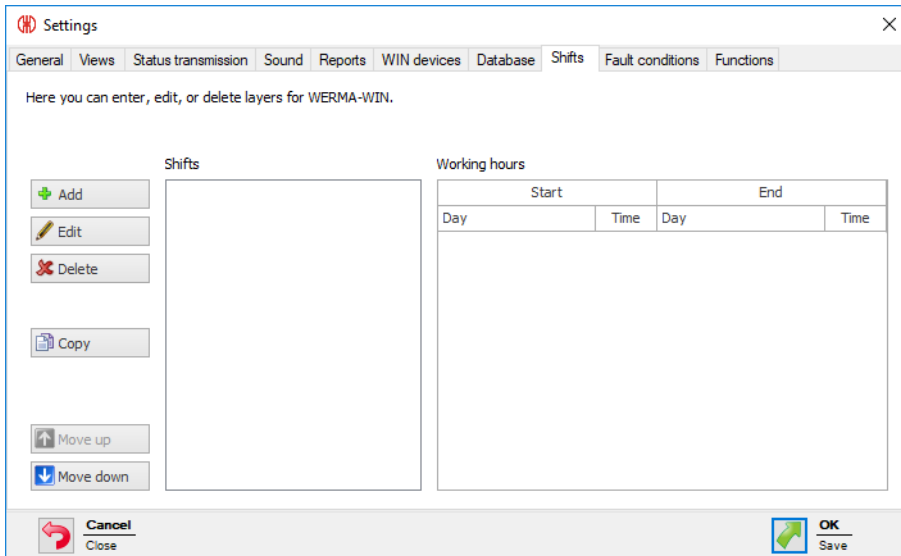

**i** The **Shifts** list displays all currently available shifts. Deleted shifts are not displayed.

### 3.7.8.1 Setting up a shift

1. Click on **Add**.  
→ The **Set up new shift** window appears.

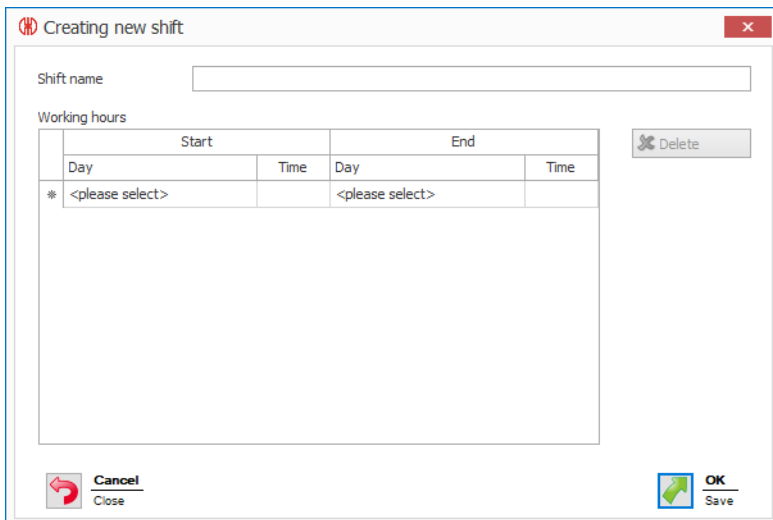

2. Enter the name for the shift in the **Shift name** field.
3. Click on **<please select>** in the **Start** column in the **Working hours** list and select the required day.
4. Enter the time at which the shift is to start in the **Time** column.
5. Select the **Day** and the **Time** at which the shift is to end in the **End** area.



- i Shifts can be defined to span more than one day, for instance Sunday 22:00 until Monday 05:00.

- i Pause times can be defined by leaving corresponding gaps in the time periods on a respective day.

Working hours

Start		End	
Day	Time	Day	Time
Monday	05:00	Monday	09:00
Monday	09:30	Monday	13:30

6. Press the Tab key to enter a new line.
7. Enter the times for all other days.
8. Click on **OK** to save the shift.

- i You can also assign shifts to the individual WIN slave in the **Control station** module in the *Configuration*.

### 3.7.8.2 Modifying shifts

- i If a shift, which is already assigned to a machine, is to be changed, then the changes will have a retrospective impact on all analysis, representations and reports. No history is saved of the changes to the shift.

WERMA recommends that you do not change shifts and, instead, create a new shift.

1. Select the required shift in the **Shifts** list.
2. Click on **Edit**.  
→ The **Edit shift** window appears.

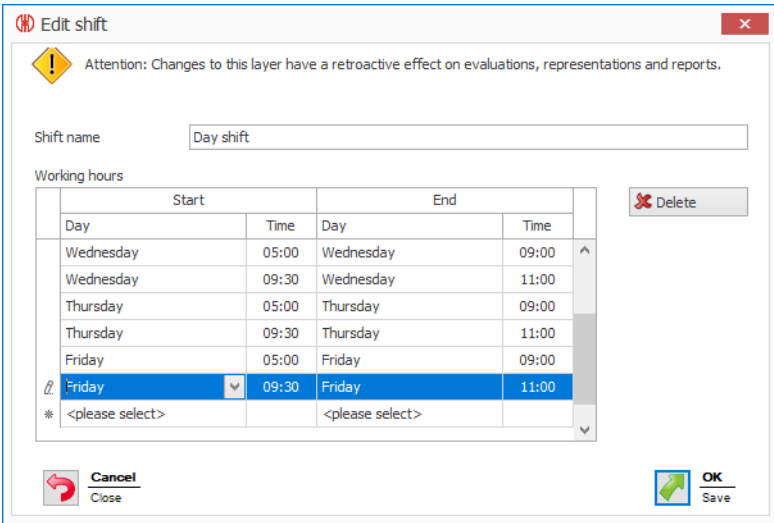

**Edit shift**

Attention: Changes to this layer have a retroactive effect on evaluations, representations and reports.

Shift name: Day shift

Working hours

Start		End	
Day	Time	Day	Time
Wednesday	05:00	Wednesday	09:00
Wednesday	09:30	Wednesday	11:00
Thursday	05:00	Thursday	09:00
Thursday	09:30	Thursday	11:00
Friday	05:00	Friday	09:00
Friday	09:30	Friday	11:00
* <please select>		<please select>	

Buttons: Cancel/Close, Delete, OK/Save

3. Modify the shift as required.
4. Click on **OK** to save the settings.

### 3.7.8.3 Copying shifts

1. Select the shift to be copied in the **Shifts** list.
2. Click on **Copy**.  
→ The **Copy shift** window appears.

Start		End	
Day	Time	Day	Time
Monday	05:00	Monday	09:00
Monday	09:30	Monday	11:00
Tuesday	05:00	Tuesday	09:00
Tuesday	09:30	Tuesday	11:00
Wednesday	05:00	Wednesday	09:00
Wednesday	09:30	Wednesday	11:00
Thursday	05:00	Thursday	09:00
Thursday	09:30	Thursday	11:00
Friday	05:00	Friday	09:00
Friday	09:30	Friday	11:00

3. Modify the name of the shift in the **Shift name** field.  
Modify the **Time periods** of the shift if you need to.
4. Click on **OK** to copy the shift.

### 3.7.8.4 Sorting shifts

1. Select the required shift in the **Shifts** list.
2. Click **Move up** or **Move down** to move the shift.

---

**i** Shifts arranged at the top of the list appear first in the selection list in the **Productivity** module.

---

### 3.7.8.5 Deleting shifts

---

**i** If a shift is to be deleted that is not assigned to a machine, then the data will be fully deleted from the database.

If a shift is to be deleted that is assigned to a machine, then the data is retained. The shift will no longer be displayed in the **Shifts** list.

---

1. Select the shift to be deleted in the **Shifts** list.

2. Click on **Delete**.
3. Confirm the prompt with **Yes**.

### 3.7.9 Fault conditions

Company-specific fault conditions (e.g. lack of material) can be defined for the creation of notes in the **Runtime** module. When an error occurs, it is possible to select from the predefined fault conditions.

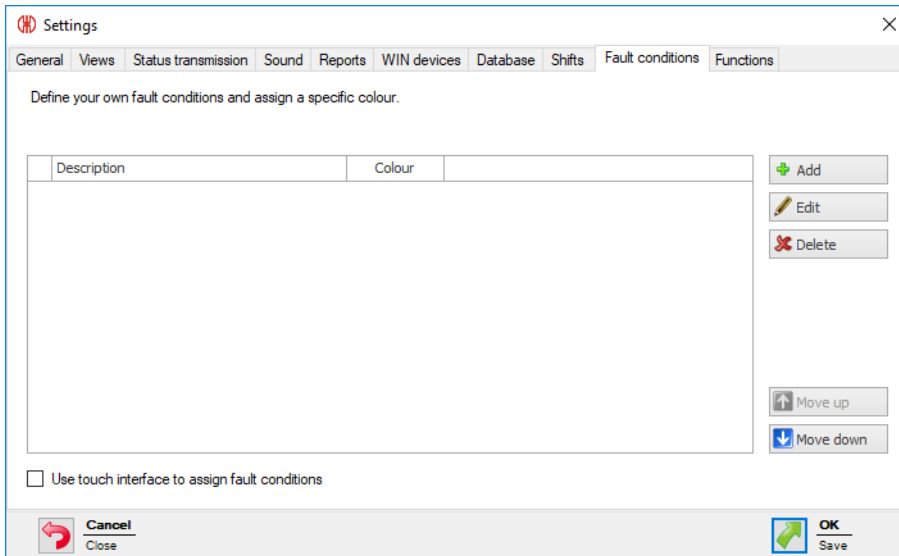

**Use touch interface to assign fault conditions** must be enabled to show the display version for the **Touch interface** instead of the **Edit note** window in the event of an error. A defined fault condition can only be selected in this case.

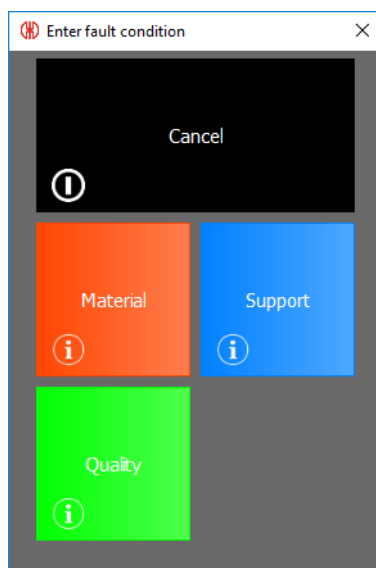

### 3.7.9.1 Adding fault conditions

1. Click on **Add**.  
→ The **Enter fault condition** window appears.

2. Enter the fault condition in the **Description** field.
3. Select a **Colour** for the fault condition.
4. Enter additional information in the **Additional note** field if necessary.
5. Click on **OK** to save the settings.

### 3.7.9.2 Modifying fault conditions

1. Select the required fault condition in the list of fault conditions.
2. Click on **Edit**.  
→ The **Edit fault condition** window appears.

3. Modify the fault condition as required.
4. Click on **OK** to save the settings.

### 3.7.9.3 Collating fault conditions

1. Select the required fault condition in the list of fault conditions.
2. Click on **Move up** or **Move down** to move the fault conditions.

**i** Fault conditions arranged at the top of the list of fault conditions appear first in the selection list in the **Runtime** module.

### 3.7.9.4 Deleting fault conditions

1. In the list of fault conditions, select the fault condition to be deleted.
2. Click **Delete**.
3. Confirm the prompt with **Yes**.

### 3.7.10 Functions

Complete modules or individual functions of modules that are to be available at a workplace can be *enabled or disabled* in the **Functions** tab.

**Settings** can also be *protected* by a password to prevent unauthorised access.

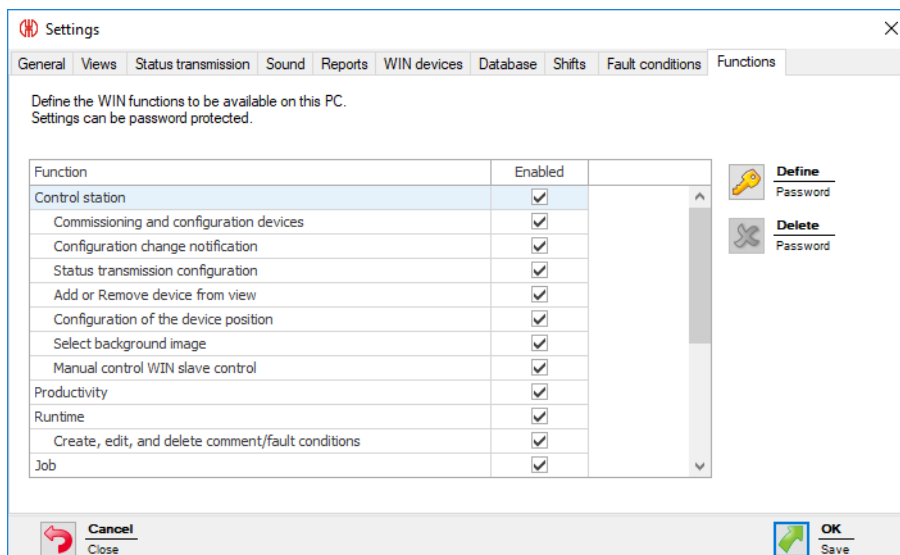

#### 3.7.10.1 Enabling and disabling modules or functions

**i** All the functions of the module are disabled as soon as a module is disabled. This also applies to functions where the checkbox is enabled in the **Enabled** column.

#### Enabling modules

1. Enable the checkbox beside the required module in the list.

Function	Enabled
Control station	<input checked="" type="checkbox"/>
Commissioning and configuration devices	<input checked="" type="checkbox"/>
Configuration change notification	<input checked="" type="checkbox"/>
Status transmission configuration	<input checked="" type="checkbox"/>
Add or Remove device from view	<input checked="" type="checkbox"/>
Configuration of the device position	<input checked="" type="checkbox"/>
Select background image	<input checked="" type="checkbox"/>
Manual control WIN slave control	<input checked="" type="checkbox"/>
<b>Productivity</b>	<input checked="" type="checkbox"/>
Runtime	<input checked="" type="checkbox"/>
Create, edit, and delete comment/fault conditions	<input checked="" type="checkbox"/>

2. Click on **OK** to save the settings.

## Enabling individual functions of a module

1. Enable the checkbox beside the required function in the list.

Function	Enabled
Show 'Control station' module	<input checked="" type="checkbox"/>
<b>-&gt; Manual switching of WIN slave control</b>	<input checked="" type="checkbox"/>
Show 'Productivity' module	<input checked="" type="checkbox"/>

2. Click on **OK** to save the settings.

## Disabling modules

1. Disable the checkbox beside the required module in the list.

Function	Enabled
Control station	<input checked="" type="checkbox"/>
Commissioning and configuration devices	<input checked="" type="checkbox"/>
Configuration change notification	<input checked="" type="checkbox"/>
Status transmission configuration	<input checked="" type="checkbox"/>
Add or Remove device from view	<input checked="" type="checkbox"/>
Configuration of the device position	<input checked="" type="checkbox"/>
Select background image	<input checked="" type="checkbox"/>
Manual control WIN slave control	<input checked="" type="checkbox"/>
<b>Productivity</b>	<input type="checkbox"/>
Runtime	<input checked="" type="checkbox"/>
Create, edit, and delete comment/fault conditions	<input checked="" type="checkbox"/>

2. Click on **OK** to save the settings.

## Disabling individual functions of a module

1. Disable the checkbox beside the required function in the list.

Function	Enabled
Show 'Control station' module	<input checked="" type="checkbox"/>
<b>-&gt; Manual switching of WIN slave control</b>	<input type="checkbox"/>
Show 'Productivity' module	<input checked="" type="checkbox"/>

2. Click on **OK** to save the settings.

### 3.7.10.2 Protecting settings with a password

1. Click on **Define**.

→ The **Enter password** window appears.

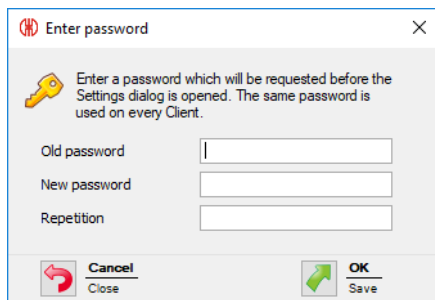

2. Enter the existing password in the **Old password** field.

---

 If no password has been assigned, leave the **Old password** field empty.

---

3. Enter a new password in the **New password** field and in the **Repetition** field.

4. Click on **OK** to protect the settings with the password entered.

### 3.7.10.3 Deleting a password

You can delete a password if access to the settings is to be possible again without a password once a password has been set.

1. Click on **Delete**.

2. Confirm the prompt with **Yes**.

### 3.7.10.4 Resetting a password

You can reset the password system-wide if you have lost the password and you can no longer open the settings.

1. Open the **WERMA-WIN Administration Console** on the server PC.

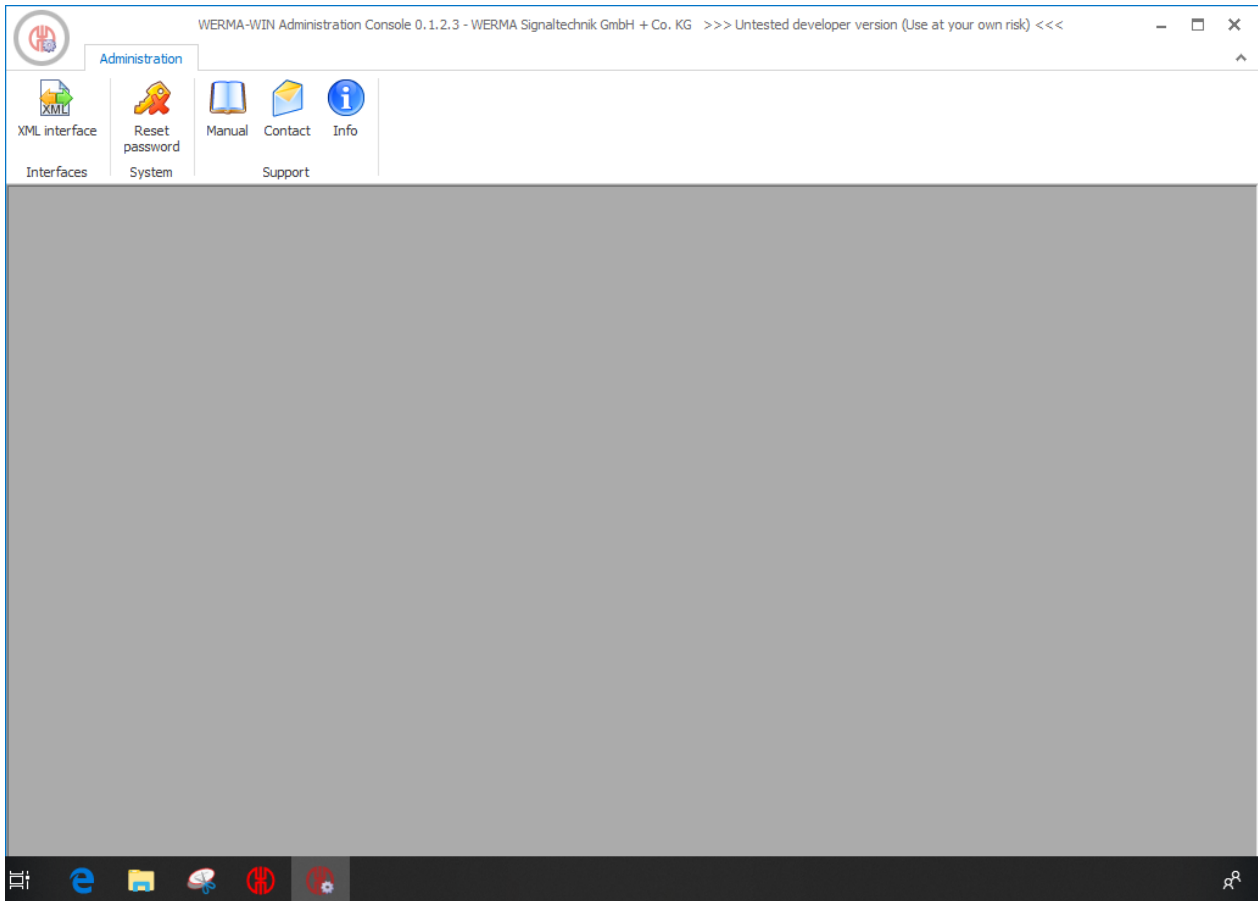

2. In the toolbar, click on **Reset password**.
3. Enable **I have understood and wish to reset the system password**.
4. Click on **Reset password**.

---

 The settings can be changed by all users once the password has been reset. WERMA recommends immediately *Issuing a new password*.

---

## 3.8 Reports and exports

In the print preview, the export can be adapted or exported before printing.

---

 Company name and logo can be modified under *Settings*.

---





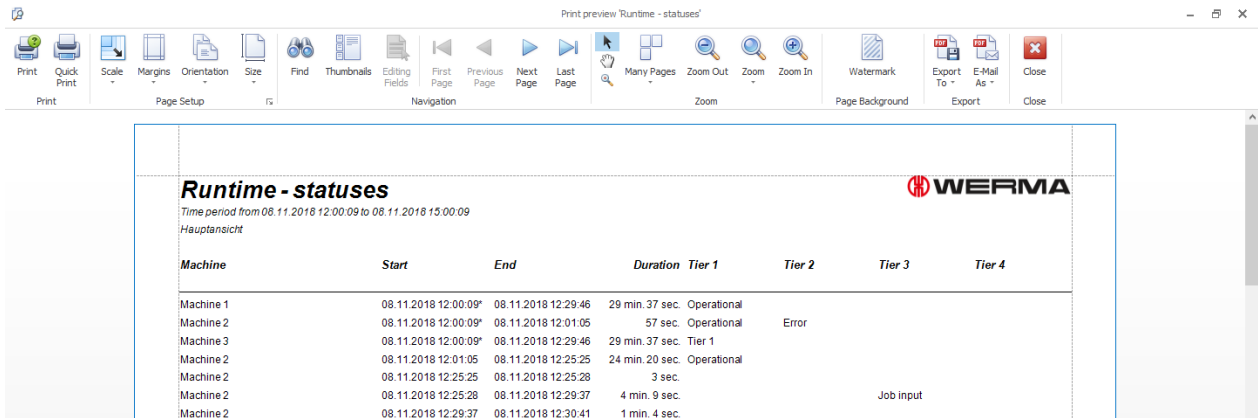



















Print preview 'Runtime - statuses'



**Runtime - statuses**  
 Time period from 08.11.2018 12:00:09 to 08.11.2018 15:00:09  
 Hauptansicht

Machine	Start	End	Duration	Tier 1	Tier 2	Tier 3	Tier 4
Machine 1	08.11.2018 12:00:09*	08.11.2018 12:29:46	29 min. 37 sec.	Operational			
Machine 2	08.11.2018 12:00:09*	08.11.2018 12:01:05	57 sec.	Operational	Error		
Machine 3	08.11.2018 12:00:09*	08.11.2018 12:29:46	29 min. 37 sec.	Tier 1			
Machine 2	08.11.2018 12:01:05	08.11.2018 12:25:25	24 min. 20 sec.	Operational			
Machine 2	08.11.2018 12:25:25	08.11.2018 12:25:28	3 sec.				
Machine 2	08.11.2018 12:25:28	08.11.2018 12:29:37	4 min. 9 sec.			Job input	
Machine 2	08.11.2018 12:29:37	08.11.2018 12:30:41	1 min. 4 sec.				

Function	Description
<b>Print</b>	
 Print	Print report. The print settings can be adapted.
 Quick Print	Print report on the default printer without adapting print settings.
<b>Page Settings</b>	
 Scale	Zoom into or zoom out of the report as a percentage or to page width.
 Margins	Adapt page margins.
 Orientation	Adapt page orientation (portrait or landscape).
 Size	Adapt paper size of the report. <b>Note:</b> All reports are optimised for <b>A4</b> .
<b>Navigation</b>	
 Find	Search for text in the report.
 Thumbnails	Show and hide miniature view of the report.
 First Page	Move to first page.
 Previous Page	Move to previous page.
 Next Page	Move to next page.

Function	Description
 Last Page	Move to last page.
<b>Zoom</b>	
	Enable default cursor.
	Enable the hand cursor to drag the print preview of the report with the cursor.
	Select the zoom cursor to zoom out of or zoom into the print preview.
 Many Pages	Display multiple pages in the print preview.
 Zoom Out	Zoom out of print preview.
 Zoom	Set zoom to a fixed value.
 Zoom In	Zoom into print preview.
<b>Background</b>	
 Watermark	<i>Paste</i> a watermark into a report. <i>Delete</i> a watermark in a report.
<b>Export</b>	
 Export To	Export report. The export <i>file format</i> can be selected.
 E-Mail As	Send report as e-mail attachment. The e-mail attachment <i>file format</i> can be selected.
<b>Close</b>	
 Close	Close print preview.

### 3.8.1 Pasting a watermark

An individual text, an image or a combination of text and image can be used as a watermark.

1. Click on **Watermark** in the toolbar.  
→ The **Watermark** window appears.

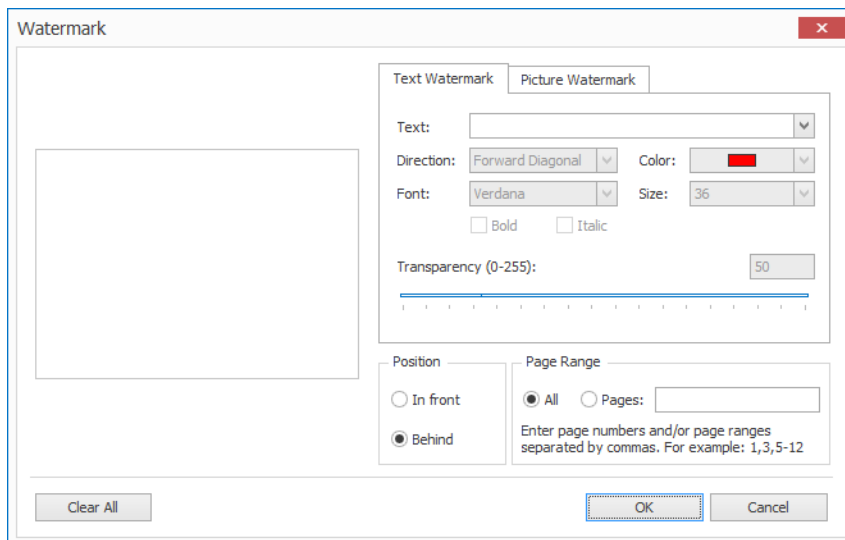

2. Enter the text on the **Text** tab and format it as required.
3. Upload a picture on the **Picture** tab and format it as required.
4. Select the position of the watermark in the **Position** area.
5. In the **Page range** area, select the pages on which the watermark is to be inserted.

---

**i** Multiple single pages are separated by a semicolon (;) (e.g. 3;5;7).  
Page ranges are specified by a dash (e.g. 3-5)

---

6. Click on **OK** to paste the watermark.

### 3.8.2 Deleting a watermark

1. Click on **Watermark** in the toolbar.  
→ The **Watermark** window appears.

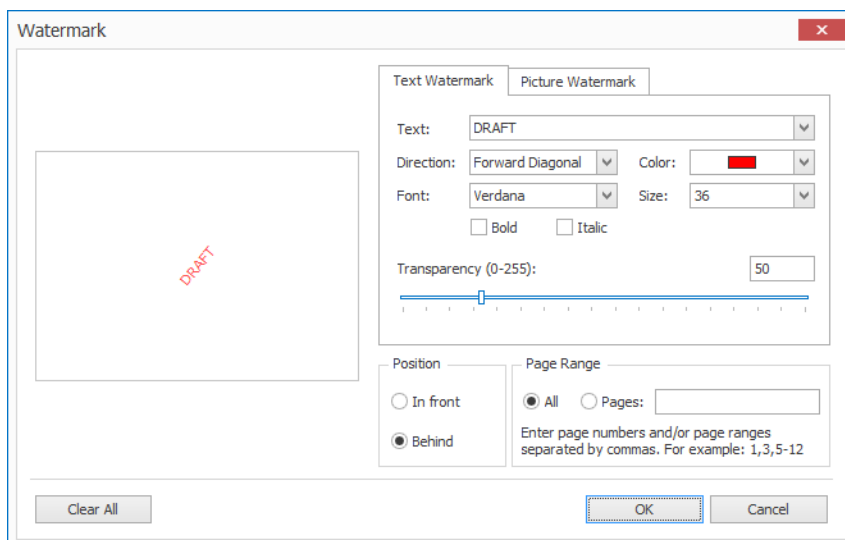

2. Click on **Clear All** to delete the watermark.
3. Click **OK** to apply the settings.

### 3.8.3 File formats

The following file formats are available for export and as an e-mail attachment:

File format	Export	E-mail attachment
PDF file	✓	✓
HTML file	✓	
DOCX file	✓	✓
Excel 2007 document	✓	✓
CSV file	✓	✓
Picture file	✓	✓

#### 3.8.3.1 PDF export options

Option	Description
<b>Page range</b>	Limit page range for export with multi-page reports (e.g. 2-4).
<b>Don't embed these fonts</b>	
<b>Export editing fields to AcroForms</b>	Export editing fields for AcroForms.
<b>Convert images to JPEG</b>	Convert images to JPEG when exporting.
<b>Image quality</b>	Adjust image quality. A higher quality generates larger PDF files.
<b>PDF/A compatibility</b>	Select compatibility of the PDF file.

Option	Description
<b>Password security</b>	Protect PDF file with password.
<b>Digital signature</b>	Sign PDF file with a digital signature
<b>Application</b>	Name of the application that created the PDF (e.g. WIN)WERMA-WIN
<b>Author</b>	Author of the author of the exported PDF file
<b>Keywords</b>	Keywords for description of the contents
<b>Subject</b>	Subject c
<b>Title</b>	Title of the exported PDF file

### 3.8.3.2 HTML export options

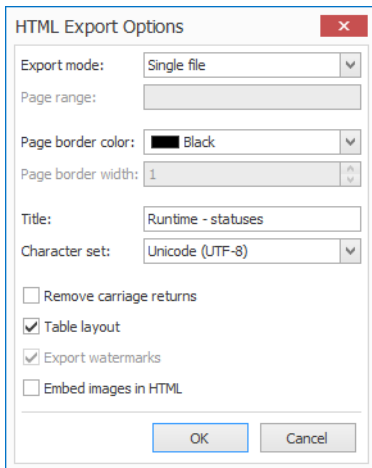

Option	Description	
<b>Export mode</b>	<b>Single file</b>	Export report as a single file.
	<b>Single file page-by-page</b>	Export report as a single file. The individual pages are formatted as shown in the preview.
	<b>Different files</b>	Export each page of the report as a separate HTML file.
<b>Page range</b>	Limit page range for export with multi-page reports (e.g. 2-4).	
<b>Page border color</b>	Define the colour of the page margins.	
<b>Page border width</b>	Define width of page margins.	
<b>Title</b>	Define the title of the export.	
<b>Character set</b>	Define the character set of the export.	
<b>Remove carriage returns</b>	Delete line breaks in HTML code.	
<b>Table layout</b>	Use tables for export layout	
<b>Export watermarks</b>	Issue watermark with export	
<b>Embed images in HTML</b>	Integrate images into the HTML file and do not save in a separate image folder.	

### 3.8.3.3 DOCX export options

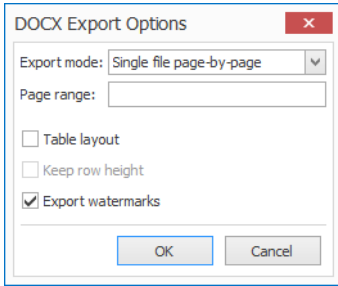

Option	Description	
<b>Export mode</b>	<b>Single file</b>	Export report as a single continuous file.
	<b>Single file page-by-page</b>	Export report as a single file. The individual pages are formatted as shown in the preview.
<b>Page range</b>	Limit page range for export with multi-page reports (e.g. 2-4).	
<b>Table layout</b>	Use tables for export layout	
<b>Keep row height</b>	Maintain line height for export with table layout	
<b>Export watermarks</b>	Issue watermark with export	

### 3.8.3.4 XLSX export options

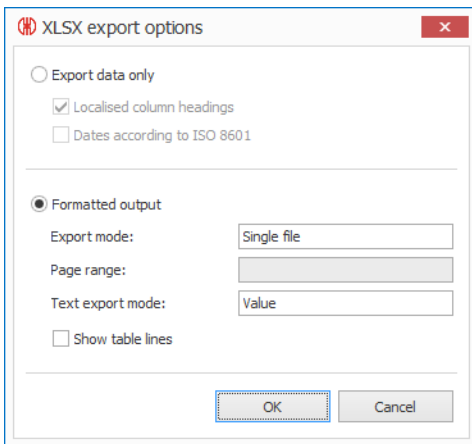

Option	Description	
<b>Export data only</b>	Export data unformatted.	
	<b>Localised column headings</b>	Translate column headings.
	<b>Dates according to ISO 8601</b>	Format dates according to ISO-8601 format.
<b>Formatted output</b>	Export data with formatting.	
<b>Export mode</b>	<b>Single file</b>	Export report as a single file.

Option	Description		
	<table border="1"> <tr> <td data-bbox="933 241 1262 658"><b>Single file page-by-page</b></td> <td data-bbox="1262 241 1428 658">Export report as a single file.  The individual pages are formatted as shown in the pre-view.</td> </tr> </table>	<b>Single file page-by-page</b>	Export report as a single file.  The individual pages are formatted as shown in the pre-view.
<b>Single file page-by-page</b>	Export report as a single file.  The individual pages are formatted as shown in the pre-view.		
<b>Page range</b>	Limit page range for export with multi-page reports (e.g. 2-4).		
<b>Text export mode</b>	<table border="1"> <tr> <td data-bbox="933 734 1262 920"><b>Text</b></td> <td data-bbox="1262 734 1428 920">Issue values (e.g. dates) as text.</td> </tr> </table>	<b>Text</b>	Issue values (e.g. dates) as text.
	<b>Text</b>	Issue values (e.g. dates) as text.	
<table border="1"> <tr> <td data-bbox="933 920 1262 1249"><b>Value</b></td> <td data-bbox="1262 920 1428 1249">Issue values (e.g. dates) as values with user-defined number format.</td> </tr> </table>	<b>Value</b>	Issue values (e.g. dates) as values with user-defined number format.	
<b>Value</b>	Issue values (e.g. dates) as values with user-defined number format.		
<b>Show table lines</b>	Show or hide grid lines in Microsoft® Excel.		

### 3.8.3.5 CSV export options

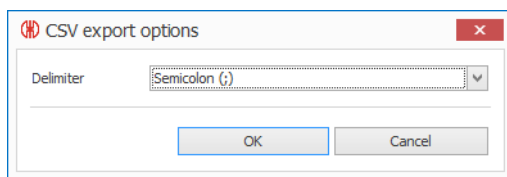

Option	Description
<b>Delimiter</b>	Define delimiters between the individual values.

### 3.8.3.6 Image export options

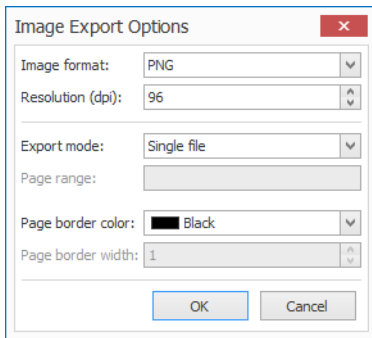

Option	Description	
<b>Image format</b>	Define the file format of the graphics export. Possible formats: <ul style="list-style-type: none"> <li>– BMP</li> <li>– EMF</li> <li>– WMF</li> <li>– GIF</li> <li>– JPEG</li> <li>– PNG</li> <li>– TIFF</li> </ul>	
<b>Resolution (dpi)</b>	Define the resolution of the graphics export. The higher the resolution, the better the image quality of the export, but the larger the file size of the export file.	
<b>Export mode</b>	<b>Single file</b>	Export report as a single file.
	<b>Single file page-by-page</b>	Export report as a single file. The individual pages are formatted as shown in the preview.
	<b>Different files</b>	Export each page of the report as a separate file.
<b>Page range</b>	Limit page range for export with multi-page reports (e.g. 2-4).	
<b>Page border color</b>	Define the colour of the page margins.	
<b>Page border width</b>	Define width of page margins.	



## 4 Automation interfaces

WERMA-WIN has 3 automation interfaces.

The *XML interface* makes it possible to make data available to third-party programs or to import data from a third-party program into WERMA-WIN.

The *WINtoApplication* makes it possible for the statuses of a signal tower to be transmitted to an external application.

The *WERMA-WIN CLI Tool* makes it possible for external applications to switch a WIN slave control controlled by the program.

### 4.1 XML interface

The XML interface consists of an *export* and an *import* module. It is possible to enable or disable both modules separately.

Information about imports and exports currently in progress as well as the status of the XML interface is displayed in the **Interface status** area.



The XML interface is set up on the (server) PC on which the WERMA-WIN server service is executed.

For optimum availability of the XML interface, WERMA recommends:

- Saving the export file or import file on a local data medium (not on a network drive).
- Setting up an exception in the virus scanner for the export file and the import directory so that the export file is not completely scanned on every export.
- Setting up write authorisation for the WERMA-WIN server service for the directory. The WERMA-WIN server service is executed under Windows user account **Network Service**.

WERMA-WIN does not archive the exported data. For error analysis purposes, WERMA recommends archiving the XML export files in the external system.

---

#### 4.1.1 Export

During the export process changes to statuses, counter values and jobs are exported incrementally to an XML file. This sees a record written to the XML file for each change.

##### 4.1.1.1 Configuring the XML interface

1. **WERMA-WIN** Open the **Administration Console** on the server PC.

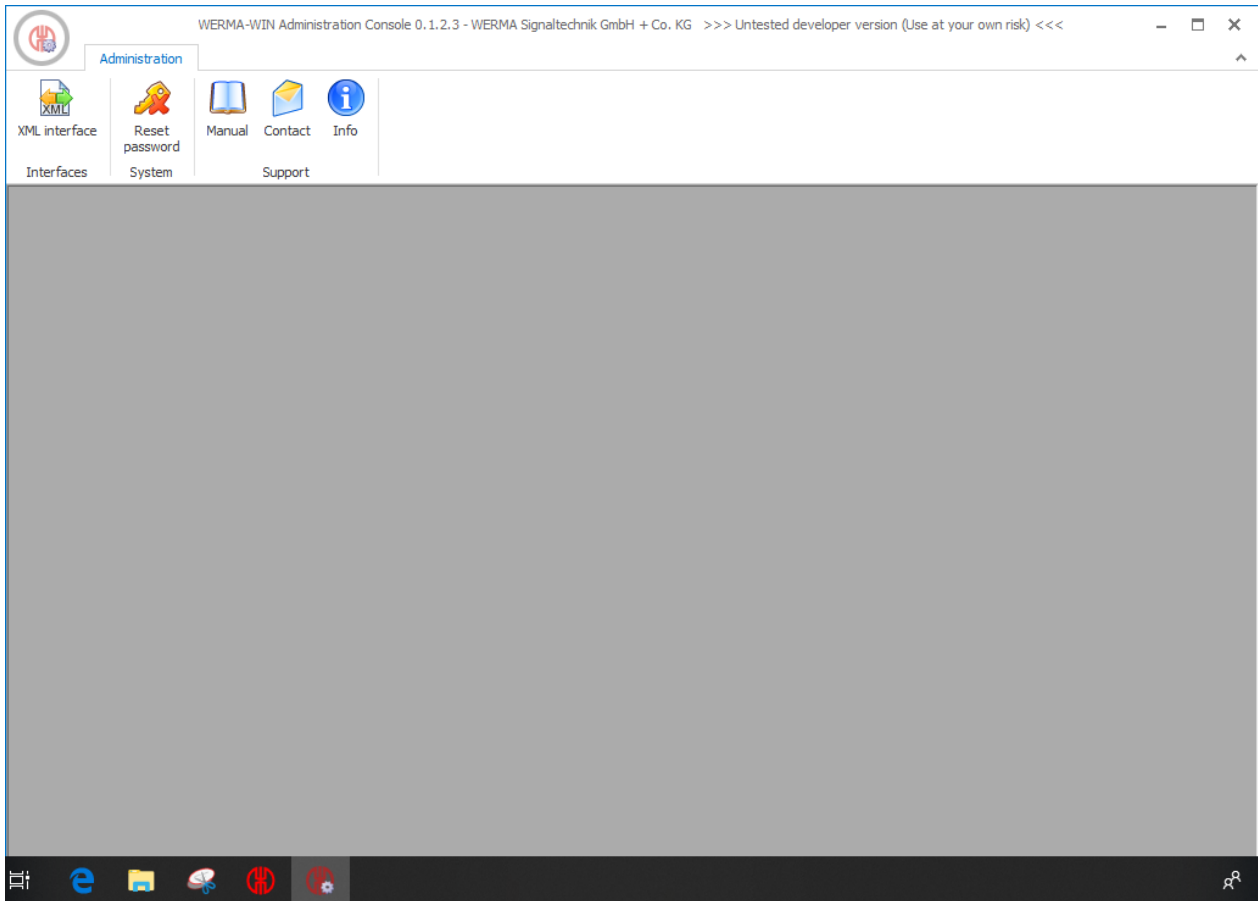

2. In the **Interfaces** area of the toolbar, click on **XML interface**.  
 → The **XML interface** window appears.

3. Select the **Export** tab.

4. In the **Configuration** area click on **Search**  then select the file location and also enter the name of the XML file.

5. If required, enter the system ID of the WERMA-WIN system in the field **System ID**.

- 
- i** Entering the system ID makes it possible to unambiguously identify different WERMA-WIN systems while processing the data.
- 

#### 4.1.1.2 Enabling the XML interface

1. Click on **Enable**.

- 
- i** If the XML interface is enabled for the first time, WERMA recommends performing a one-off *manual* export of the data.
- 

#### 4.1.1.3 Disabling the XML interface

1. Click on **Disable**.

- 
- i** WERMA-WIN does not archive the exported data. For error analysis purposes, WERMA recommends archiving the XML export files in the external system.
- 

#### 4.1.1.4 Element and attribute description

- 
- i** WERMA recommends that you ignore unknown elements and attributes when processing the XML export file.
- 

#### General attributes

Attributes	Data type	Description	Values
rowid	[bigint]	This is increased consecutively with each exported record; it is unique for each record.  The external system should import each rowid only once to detect duplicates in the event an error occurs.  rowid can be	

Attributes	Data type	Description	Values
		used as the primary key for the data records	
timestamp	[datetime]	Time stamp in ISO 8601 format	
refid	Different, see data type at the respective element	The refid specifies the internal ID in the WERMA-WIN database when database objects are exported directly.	

### <data>

<data> contains all export data.

Attributes	Data type	Description	Values
version	[nvarchar] (20)	Version of the XML schema definition	
systemid	[nvarchar] (25)	System ID, which was configured in the WERMA-WIN Administration Console.	
appname	[nvarchar] (max)	Name of the exporting application	
appversion	[nvarchar] (20)	Version number of the exporting application	

### <slaveref>

Reference to a WIN slave. It is possible to use the refid or the macid to unequivocally identify a WIN slave.

Attributes	Data type	Description	Values
refid	[smallint]	The refid specifies the internal ID in the WERMA-WIN database when database objects are exported directly.	
macid	[nvarchar] (6)	Assignment to a WIN slave via the	

Attributes	Data type	Description	Values
		wireless MAC address Notation: Lower case letters without hyphens	

### <slavestate>

A new status was received for a WIN slave.

Attributes	Data type	Description	Values
tier1	[tinyint]	Status tier 1	0 = Off = Off 1 = On = On 2 = Blinking = Blinking 3 = [Error] = Connection error
tier2	[tinyint]	Status tier 2	
tier3	[tinyint]	Status tier 3	
tier4	[tinyint]	Status tier 4	

### <counterinfo>

A new counter value was received for a WIN slave performance, the counter was manually reset, or a job was started or completed.

Attributes	Data type	Description	Values
tier	[tinyint]	Configured counter tier	1 = Tier 1 2 = Tier 2 3 = Tier 3 4 = Tier 4
value	[int]	Counter status, display in control station	Value >= 0
orderrefid	[int]	Reference to an internal job ID	

### <order>

<order> contains data belonging to a job.

Attributes	Data type	Description	Values
orderid	[int]	Job ID generated by WERMA-WIN The job ID is displayed in the job module.	
refid	[int]	The refid specifies	

Attributes	Data type	Description	Values
		the internal ID in the WERMA-WIN data-base when database objects are exported directly.	
number	[nvarchar] (60)	Selected job number	
description	[nvarchar] (250)	Selected job name	
state	[tinyint]	Current job status	1 = Waiting = Only created 2 = Processing = In progress 3 = Completed = Completed 4 = WaitForStart (see waitmode)
waitmode	[tinyint]	If state = 4, the waitmode indicates when the job will be started.	0 = Counter = Start with next piece 1 = Signal = Start, as soon as job input tier is enabled
targetamount	[decimal] (18.3)	Plan quantity	
piecespersignal	[decimal] (18.3)	Factor (number of pieces per cycle)	
timepersignal	[decimal] (18.1)	Plan cycle time in seconds	
targetsetuptime	[int]	Plan set up time in minutes	
amountcorrection	[decimal] (18.3)	Actual correction (piece)	
realbegintime	[datetime]	Time when the job was started (or empty character string)	
realendtime	[datetime]	Time when the job was ended (or empty character string)	
realsetuptime	[int]	Actual set up time	
realamount	[decimal] (18.3)	Actual quantity Is set only once the job is ended. It is pos-	

Attributes	Data type	Description	Values
		sible to determine the quantity of pieces until the job is completed using <counterinfo> in the XML interface.	
autostoptimeenabled	[bit]	The job is completed automatically taking into consideration: - autoStopTime - autostoptimedays	0 = Job will not be completed 1 = Job will be completed
autostoptime	[datetime]	Time at which the job is to be exited automatically	
autostoptimedays	[int]	Specifies after how many days the job is to be ended.	
autostoptargetamount	[bit]	Job is completed automatically as soon as the plan quantity is reached.	0 = Job will not be completed 1 = Job will be completed

### <deleteinfo>

<deleteinfo> flags a record as deleted.

Attributes	Data type	Description	Values
type		Record type	order
refid	[int]	Internal record ID	

### <sync>

<sync> highlights the start and the end of the XML export.

Attributes	Description	Values
state	Specifies if the sync tag stands for the start (started) or the end (completed) of the synchronisation.	
syncid	Unambiguous GUID to assign the sync end to the start.	

## 4.1.1.5 Example – XML export file

### Example of an XML export file

```
<?xml version="1.0" encoding="UTF-8"?>
<data appversion="4.5.0.1816" appname="WERMA-WIN-3.0" systemid="Wermac235" version="1.0">
  <slavestate tier4="0" tier3="0" tier2="0" tier1="0" timestamp="2018-02-14T15:03:35.5919399+01:00" rowid="551807">
    <slaveref macid="006C36" refid="1"/>
  </slavestate>
  <slavestate tier4="0" tier3="0" tier2="0" tier1="0" timestamp="2018-02-14T15:03:35.8260887+01:00" rowid="551808">
    <slaveref macid="006C79" refid="3"/>
  </slavestate>
  <slavestate tier4="0" tier3="0" tier2="0" tier1="1" timestamp="2018-02-14T15:03:41.7800895+01:00" rowid="551809">
    <slaveref macid="006C36" refid="1"/>
  </slavestate>
  <slavestate tier4="0" tier3="0" tier2="0" tier1="1" timestamp="2018-02-14T15:03:41.9988901+01:00" rowid="551810">
    <slaveref macid="006C79" refid="3"/>
  </slavestate>
  <slavestate tier4="0" tier3="0" tier2="0" tier1="2" timestamp="2018-02-14T15:03:42.0142973+01:00" rowid="551811">
    <slaveref macid="006C36" refid="1"/>
  </slavestate>
  <slavestate tier4="0" tier3="0" tier2="0" tier1="0" timestamp="2018-02-14T15:03:42.2332875+01:00" rowid="551812">
    <slaveref macid="006C79" refid="3"/>
  </slavestate>
  <slavestate tier4="0" tier3="0" tier2="0" tier1="0" timestamp="2018-02-14T15:03:58.5163838+01:00" rowid="551813">
    <slaveref macid="006C36" refid="1"/>
  </slavestate>
  <counterinfo timestamp="2018-02-14T15:12:13.9583469+01:00" rowid="551814" orderrefid="" value="0" tier="1">
    <slaveref macid="006BBD" refid="6"/>
  </counterinfo>
  <order timestamp="2018-02-14T15:13:08.2450790+01:00" rowid="551815" refid="180848" autostoptargetamount="1" autostoptimedays="1" autostoptime="00:00:00" autostoptimeenabled="0" realamount="0"
  realsetuptime="0" realendtime="" realbegintime="" amountcorrection="0" targetsetuptime="0" timepersignal="0.8" piecespersignal="10" targetamount="1000" waitmode="0" state="1" description="A00014" number="A00014"
  orderid="87677">
    <slaveref macid="006BBD" refid="6"/>
  </order>
  <order timestamp="2018-02-14T15:17:35.0651364+01:00" rowid="551816" refid="180848" autostoptargetamount="1" autostoptimedays="1" autostoptime="00:00:00" autostoptimeenabled="0" realamount="0"
  realsetuptime="0" realendtime="" realbegintime="2018-02-14T15:17:35.0494684+01:00" amountcorrection="0" targetsetuptime="0" timepersignal="0.8" piecespersignal="10" targetamount="1000" waitmode="0" state="2"
  description="A00014" number="A00014" orderid="87677">
    <slaveref macid="006BBD" refid="6"/>
  </order>
  <counterinfo timestamp="2018-02-14T15:17:35.0651364+01:00" rowid="551817" orderrefid="180848" value="0" tier="1">
    <slaveref macid="006BBD" refid="6"/>
  </counterinfo>
  <counterinfo timestamp="2018-02-14T15:17:35.0961291+01:00" rowid="551818" orderrefid="180848" value="0" tier="1">
    <slaveref macid="006BBD" refid="6"/>
  </counterinfo>
  <order timestamp="2018-02-14T15:30:47.7027443+01:00" rowid="551819" refid="180848" autostoptargetamount="1" autostoptimedays="1" autostoptime="00:00:00" autostoptimeenabled="0" realamount="0"
  realsetuptime="0" realendtime="" realbegintime="2018-02-14T15:30:47.7027443+01:00" amountcorrection="0" targetsetuptime="0" timepersignal="0.8" piecespersignal="10" targetamount="1000" waitmode="0" state="3" description="A00014" number="A00014" orderid="87677">
    <slaveref macid="006BBD" refid="6"/>
  </order>
  <counterinfo timestamp="2018-02-14T15:30:47.7495606+01:00" rowid="551820" orderrefid="" value="0" tier="1">
    <slaveref macid="006BBD" refid="6"/>
  </counterinfo>
  <counterinfo timestamp="2018-02-14T15:30:50.1872793+01:00" rowid="551821" refid="180848" type="order">
    <slaveref macid="006BBD" refid="6"/>
  </counterinfo>
</data>
```

## 4.1.1.6 Accessing the XML export

WERMA-WIN regularly opens the XML export file for write access purposes only and to check if the XML export file can be overwritten. Consequently, the XML export file must be renamed before the XML export file can be processed by an external system.

If the XML export file was renamed, WERMA-WIN creates a new file when the next export is run.



If WERMA-WIN has opened the XML export file, it cannot be renamed. In that case the external system must make several attempts to rename the XML export file.

Access can be granted to the XML export file in accordance with the following diagram:



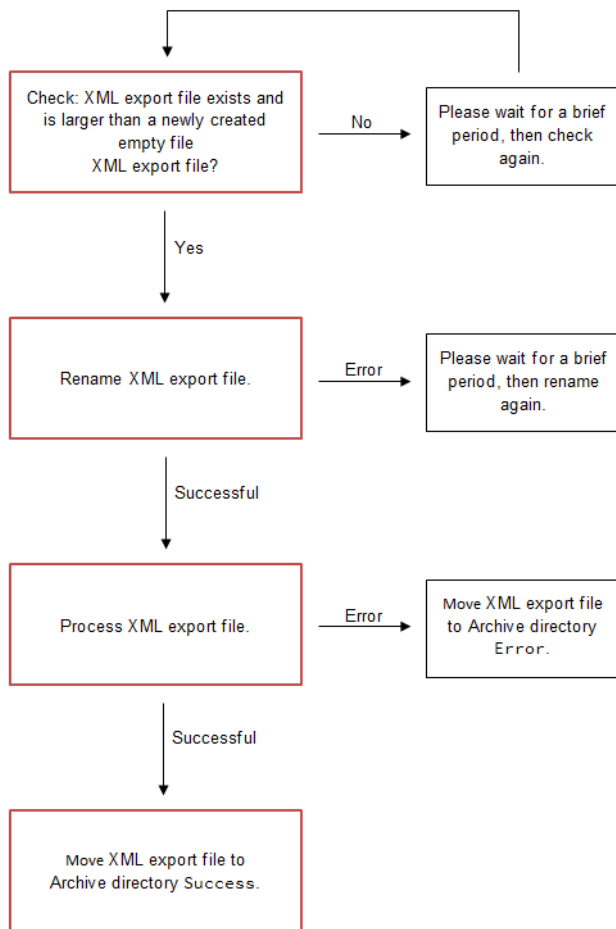

**i** To prevent a new XML export file from being created after it has been renamed, although no data needs to be processed, WERMA recommends only renaming and processing the XML export file as soon as its size exceeds 120 bytes. An empty XML export file without exported data is approx. 120 bytes in size (depending on the stored system ID).

**i** WERMA-WIN exports new data within a few milliseconds. If the external system is to process the data very quickly, WERMA recommends using the Windows API to monitor the file system or rather the XML export file (for example with `.NET FileSystemWatcher`). In this case, WERMA recommends not checking the size of the file and processing the XML export file immediately after it has been created.

#### 4.1.1.7 Exporting data manually

The manual export serves as initial synchronisation after the XML interface has been enabled for the first time. This exports all tier statuses, counter statuses and jobs. It is then subsequently possible to use the automated export interface.

1. *Configuring* the XML interface.
2. Click **Export** in the **Export current conditions** area.

---

**i** Manual export can take some time depending on the quantity of jobs.

---

## 4.1.2 Import

During the import process WERMA-WIN reads in data from an XML file. The XML file can contain several data records. The data records to be imported can be different data record types, for example, `Set up job` or `Start job`. Each data record is processed individually.

An import report is created for each imported file in the form of an XML file and saved in a dedicated directory. The filename is suffixed with `-result`.

### 4.1.2.1 Configuring the XML interface

---

**i** The filenames of the XML files to be imported in the import directory must observe a specified *schema*.

An *example* shows the structure of the XML import file.

---

1. Open the **WERMA-WIN Administration Console** on the server PC.

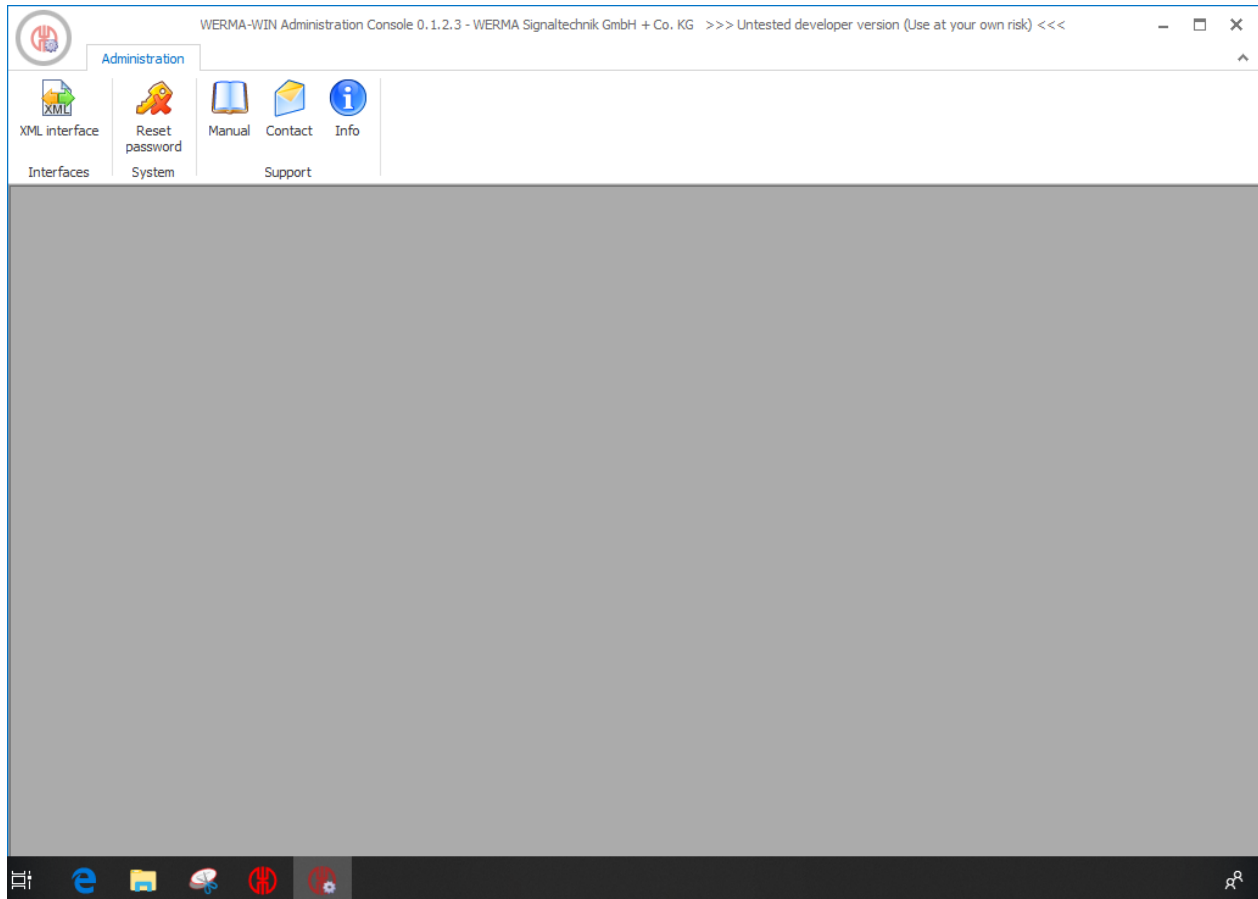

2. In the **Interfaces** area of the toolbar, click on **XML interface**.  
→ The **XML interface** window appears.
3. Select the **Import** tab.

4. In the **Configuration** area click on **Search**  and select **Import directory**.

5. Select **Results directory**, in which a results file of every imported XML file is saved.

---

 The *Results file* can be processed by the external system as feedback.

---

6. Select **Archive directory**, into which the processed XML files are moved.

7. In the **Number of days after which files will be from the archive** field, specify how long archived files should be kept.

#### 4.1.2.2 Enabling the XML interface

1. Click on **Enable**.

#### 4.1.2.3 Disabling the XML interface

1. Click on **Disable**.

 WERMA-WIN does not archive the exported data. For error analysis purposes, WERMA recommends archiving the XML export files in the external system.

---

#### 4.1.2.4 Element and attribute description

##### General attributes

Attributes	Data type	Description	Values
rowid	[nvarchar] (60)	The rowid is used for the record in the results file.  The external system is able to assign the rowid as required (max. 60 characters).  The rowid for each respective import file must be unambiguous.	
timestamp	[datetime]	Time stamp in ISO 8601 format  Date entries are evaluated as local time/time zone.	

Attributes	Data type	Description	Values
		Example: 31.12.2017 19:00:00 = 2017- 12-31T19:00:00	

### <data>

<data> contains all export data.

Attributes	Data type	Description	Values
version	[nvarchar] (20)	Version of the XML schema definition	
appname	[nvarchar] (max)	Name of the exporting application	
appversion	[nvarchar] (20)	Version number of the exporting application	
cancelonerror	[bit]	Specifies if processing of the import file is to be continued if an import error occurs.	false = Continue processing with the next record true = Cancel processing the file

### <slaveref>

Reference to a WIN slave. It is possible to use the refid or the macid to unequivocally identify a WIN slave.

Attributes	Data type	Description	Values
refid	[smallint]	Assignment to a WIN slave via the database ID	
macid	[nvarchar] (6)	Assignment to a WIN slave via the wireless MAC address  Notation: Lower case letters without hyphens	

### <orderref>

Assignment to a job. Can be selected using orderid or refid.

Attributes	Data type	Description	Values
orderid	[int]	The job ID shown	

Attributes	Data type	Description	Values
		in the user interface  The <code>orderid</code> is generated continuously. If the job with the highest <code>orderid</code> was deleted, the <code>orderid</code> for the next job is used again.	
refid	[int]	Assignment to a job via the database ID	

### Saving a job

Attributes	Data type	Description	Values
number	[nvarchar] (60)	Job number	String with 60 characters, no line breaks
description	[nvarchar] (250)	Job name	String with 250 characters, no line breaks
targetamount	[decimal] (18.3)	Plan quantity	Integer
piecespersignal	[decimal] (18.3)	Factor (number of pieces per cycle)	Integer
timepersignal	[decimal] (18.1)	Plan cycle time in seconds	Decimal number max. one place after the decimal point
targetsetuptime	[int]	Plan set up time in minutes	Integer
autostoptargetamount	[bit]	Exit job automatically when the plan quantity is reached.	true = End job false = Do not end job
autostoptimeenabled	[bit]	Exit job automatically when the autostoptime is reached.	true = End job false = Do not end job
autostoptime	[datetime]	Time at which the job is completed automatically.	Date + time: 2017-12-31T19:00:00

Attributes	Data type	Description	Values
		autostoptime evaluates the time only.	
autostoptimedays	[int]	If the job is not to be completed on the start day, it is possible to specify a number of days after which the job will be completed automatically.	

**i** Do not use the attributes ref id and order id when saving a new job.

**i** A point (.) is used as a decimal separator for decimal numbers.  
Thousands separators are not supported.  
Decimal places are ignored with quantities.

### Editing jobs

Attributes	Data type	Description	Values
amountcorrection	[int]	Actual correction  Is added to the quantity determined via clock signal.  If the actual correction is negative, it is subtracted from the determined quantity.	
realsetuptime	[int]	Actual set up time in minutes	

**i** If an attribute is not specified, the value stored to date remains valid.



When using the attributes `refid` and `orderid`:

- Specify just one of the two attributes when editing a job. If there is an option in the external system to save the `refid` generated when creating the job, the attribute `refid` should always be specified for subsequent processing operations. In that case, the attribute `orderid` need not be transferred.
- If both attributes are specified, both IDs must reference the same job.

### Deleting the assignment of a WIN slave

Attributes	Description	Values
<code>slaveref refid</code>	Delete the assignment of a WIN slave to a job.	empty
<code>slaveref macid</code>	Delete the assignment of a WIN slave to a job.	empty

### Starting jobs

Attributes	Description	Values
<code>action rowid="..." type="order-start"</code>	Start job.	
<code>action orderref refid="..." type-e="order-start"</code>	Start job.	
<code>action orderref oderid="..." type-e="order-start"</code>	Start job.	

### Changing job to active waiting

Attributes	Description	Values
<code>action rowid="..." type="order-wait-for-start" waitmode=" ..."</code>	Please wait for counter input or job input to start the job.	
<code>action orderref refid = "..." type-e="order-wait-for-start" waitmode="..."</code>	Please wait for counter input or job input to start the job.	
<code>action orderref oderid = "..." type-e="order-wait-for-start" waitmode="..."</code>	Please wait for counter input or job input to start the job.	
<code>waitmode</code>	Specification, if a counter input or job input triggers the change.	<code>signal = Job input</code> <code>counter = Counter input</code>



## Ending jobs

Attributes	Description	Values
action rowid="..." type="order-stop"	End job.	
action orderref refid ="..." type="order-stop"	End job.	
action orderref oderid ="..." type="order-stop"	End job.	

## Deleting jobs

Attributes	Description	Values
action rowid="..." type="order-delete"	Delete job.	
action orderref refid ="..." type="order-delete"	Delete job.	
action orderref oderid ="..." type="order-delete"	Delete job.	

### 4.1.2.5 Example of an XML import file

```
<?xml version="1.0" encoding="utf-8"?>
<data appname="test" appversion="1.0" cancelonerror="false" xmlns="http://www.werma-win.com/xml/1.0/import/data">
  <order rowid="1" number="AU-4711" description="alloy part 447-256" targetamount="1000" piecespersignal="1" timepersignal="2.5" />
</data>
```

 An example of an XML import file is available in the installation directory of WERMA-WIN in the Docs subdirectory.

### 4.1.2.6 File name

The filename can be assigned as desired; however, it must end with a time stamp corresponding to the format -YYYYMMDDhhmmss and the file extension .xml.

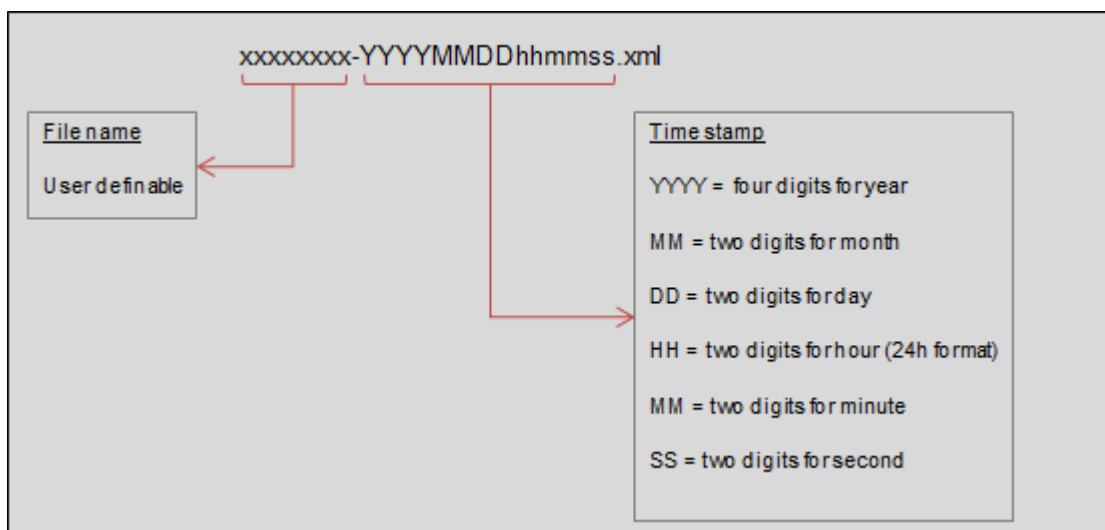

**Examples:**

order-20180301150000.xml  
config-20180301150104.xml  
start-order-20180301153041.xml

### 4.1.2.7 Results file

The results file is created during the import operation and saved to the results directory with the suffix `-result`. If the file already exists, the name is suffixed with `-0002`, `-0003` and so forth.

#### Example of a results file

```
<?xml version="1.0" encoding="utf-8"?>
<results appname="..." appversion="..." cancelonerror="false" xmlns="http://www.werma-win.com/xml/1.0/import/results">
  <!-- XML format errors etc. -->
  <result timestamp="2018-01-17T11:08:31.2922173+01:00" type="file" success="false">
    <exception type="..." message="..." />
  </result>

  <result rowid="..." timestamp="2018-01-17T11:08:31.2922173+01:00" type="order" success="false">
    <!-- If available, all ID attributes are transferred in the results file -->
    <orderref refid="4711" orderid="2" />
    <exception type="..." message="..." />
  </result>

  <result rowid="..." timestamp="2018-01-17T11:08:31.2922173+01:00" type="order" success="true">
    <orderref refid="4711" orderid="2" />
  </result>

  <!-- Process (for example, Start job) was successfully executed -->
  <result rowid="..." timestamp="2018-01-17T11:08:31.2922173+01:00" type="action" success="true" />

  <!-- Process (for example, Start job) was not successfully executed -->
  <result rowid="..." timestamp="2018-01-17T11:08:31.2922173+01:00" type="action" success="false">
    <exception type="..." message="..." />
  </result>
</results>
```

### 4.1.3 Interface status

The **Interface status** area displays information about the current state of the XML interface as well as imports and exports currently in progress.

#### Interface status

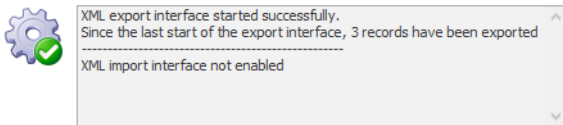

Errors are also logged in the Windows Event Viewer and in the WERMA-WIN error log.

## 4.2 WINtoApplication

The WINtoApplication allows you to transmit the statuses of a signal tower to an external application and specifically further process them in this application. This application can be set up individually for each user.

---

**i** The application data is stored, user-related, locally and not in the WERMA-WIN database. The settings of the WINtoApplication can be *exported* and *imported* for use on another PC or with another user.

---



**i** The WINtoApplication only operates with an active user login. A user must be continuously logged in.

---

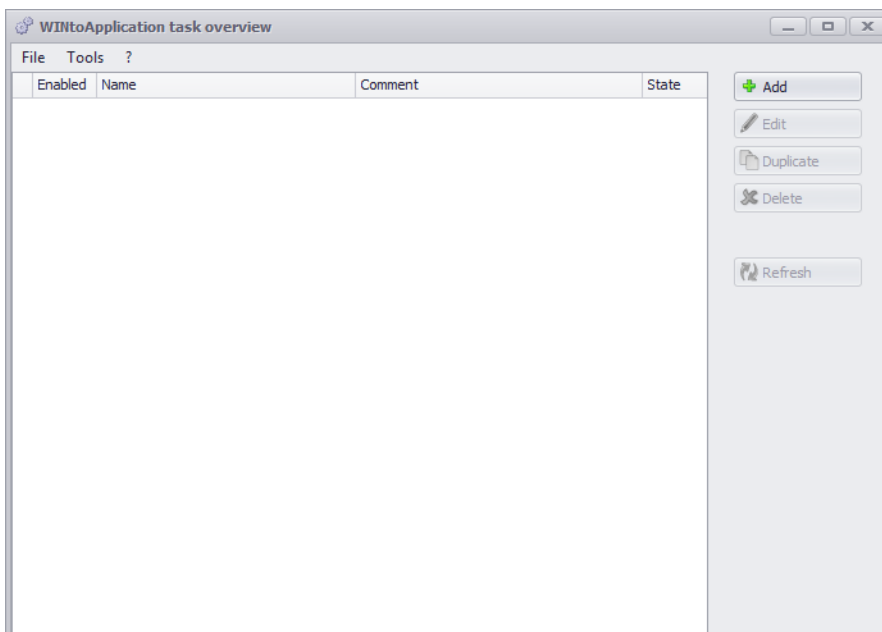
1. If the **Settings** window is not yet open, click on **Settings** in the toolbar.
2. Click on **Start WinToApplication** in the **Status transmission** tab.  
→ The **WINtoApplication task overview** window appears.



The **WINtoApplication task overview** window shows an overview and the state of all available jobs.

State	Description
	The job has been successfully performed.
	There was an error the last time the job was performed. The <i>History</i> shows error details.
	The job is running.

---

 Clicking on **Refresh** updates the job overview.

---

 The symbol in the system tray can be used to *enable and disable jobs and complete WINtoApplication*.

---

## 4.2.1 Adding a job

1. Click on **Add**.  
→ The **WINtoApplication task configuration** window appears.

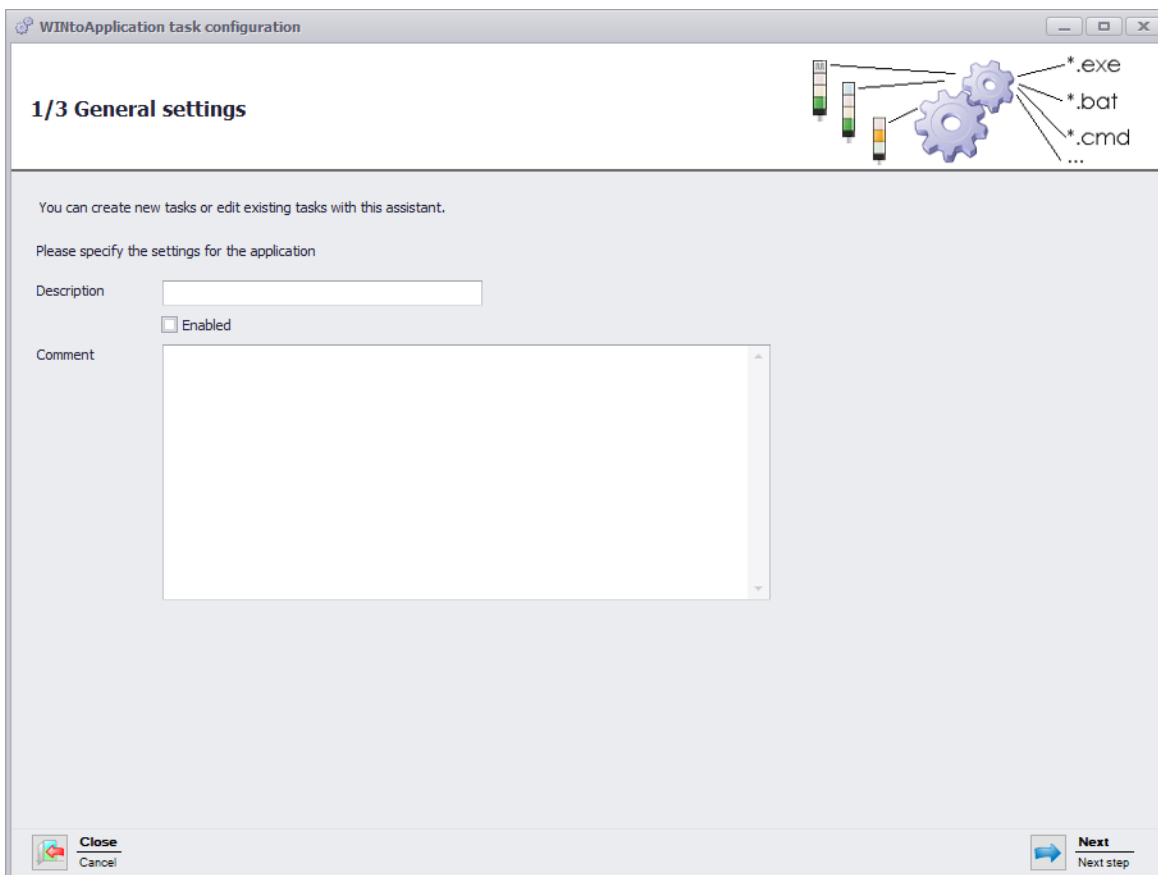

2. Enter the name of the job in the **Description** field.
3. Enter an additional description of the job in the **Comment** field, if necessary.
4. Select **Enabled** if the job is to be immediately enabled once it has been created.
5. Click on **Next**.  
→ The window to input the application settings appears.

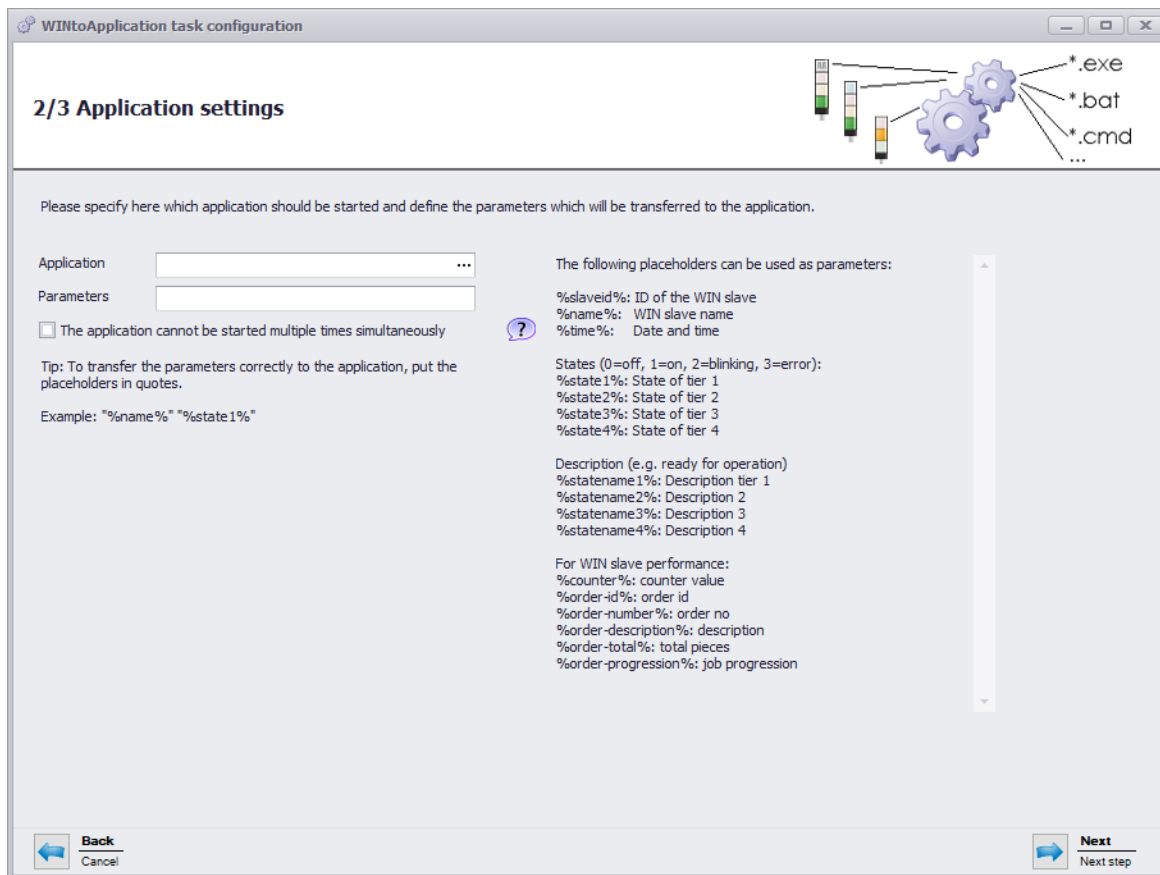

6. Click on ... in the **Application** field to select the external application.
7. In the **Parameters** field, enter the *Parameters* which are to be transmitted to the external application.
8. Enable **The application cannot be started multiple times simultaneously**, if required, to prevent the external application from being started several times simultaneously.

 By enabling **The application cannot be started multiple times simultaneously**, the program waits until the external application has ended. The external application is then called up again.

Disable **The application cannot be started multiple times simultaneously** if applications expect a multiple start.

9. Click on **Next**.  
→ The window to select the WIN slave appears.

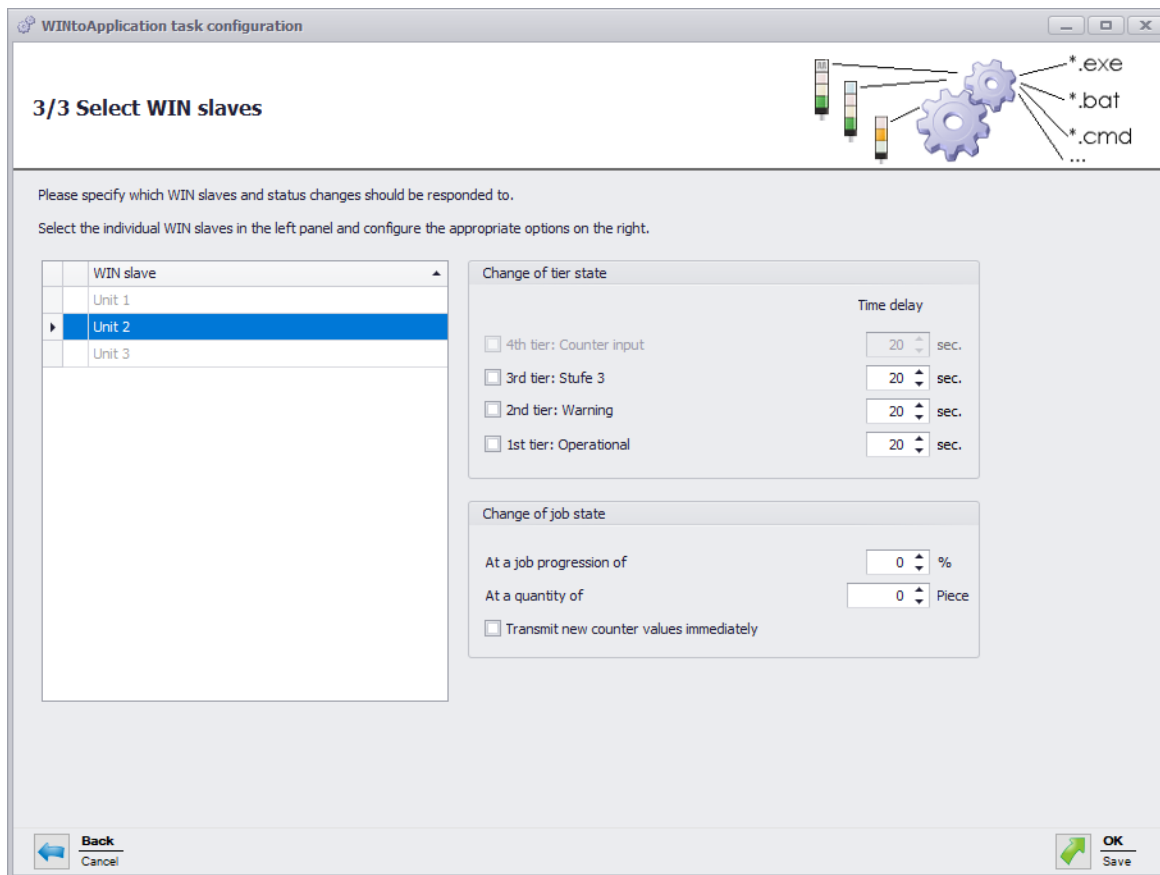

10. From the list of WIN slave, select WIN slave the status changes of which are to be transmitted.
11. In the **Change of tier state** area, select for which tiers the status changes are to be transmitted.
12. Enter a **Time delay** for each tier if necessary.

---

**i** The status change is only transmitted if the new status is unchanged during the defined **Time delay**. No status change is transmitted if the status has changed again within the **Time delay**.

---

13. In the **Change of job state** area, select at which job progression or at which quantity the status change is to be transmitted.
14. Enable **Transmit new counter values immediately** if every changed counter status is to be transmitted.

---

**i** The **Change of job state** area is only available if a WIN slave control is selected.

---

15. Click on **Next**.  
 → The window in which to create an Autostart shortcut appears.

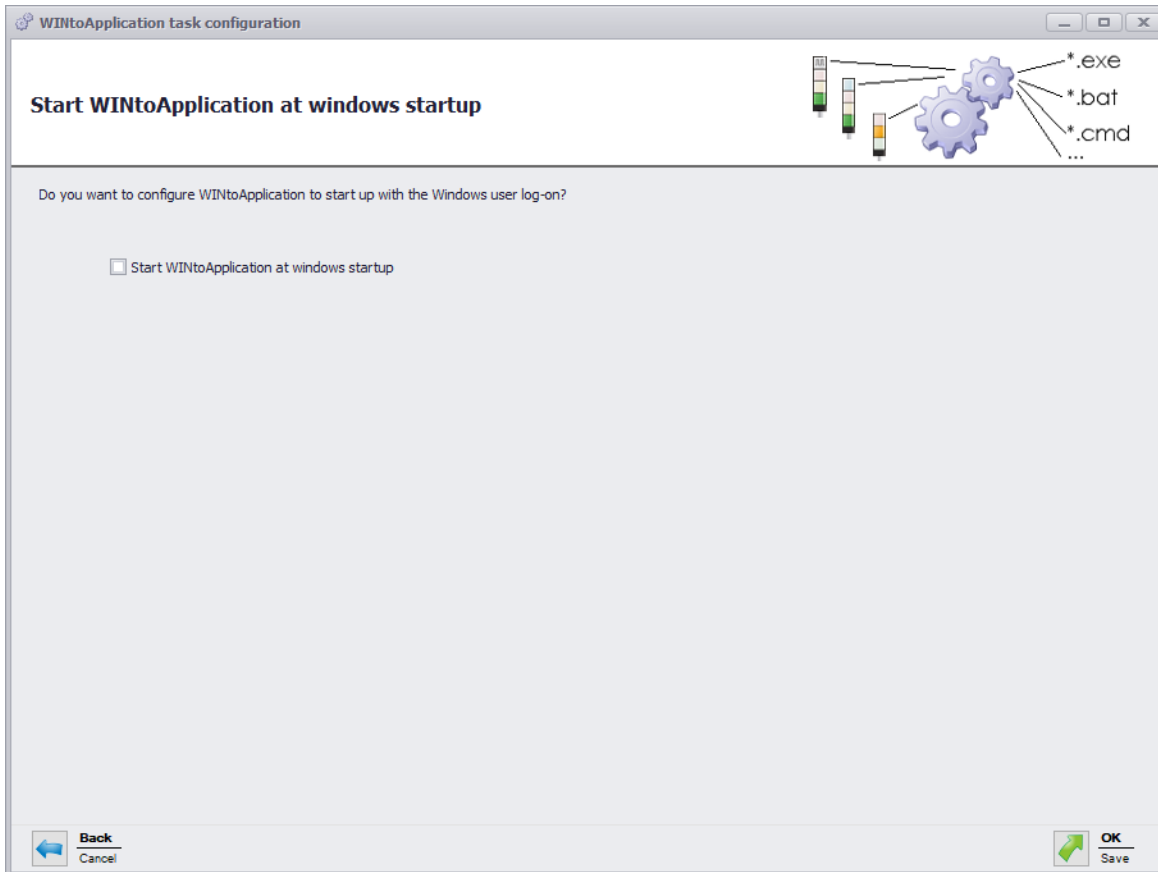

16. Enable **Start WINtoApplication at windows startup** if WINtoApplication is to be automatically started when the PC is started or after user login.
17. Click on **OK** to save the job.

#### 4.2.1.1 Placeholders/Parameters

The following placeholders/parameters are available:

Placeholders/Parameters	Description
%slaveid%	ID of the WIN slave
%name%	Description of the WIN slave
%time%	Date and time of status transmission
%reason%	Reason for status transmission
%state1%	Status of tier 1
%state2%	Status of tier 2
%state3%	Status of tier 3
%state4%	Status of tier 4
%statename1%	Description of tier 1
%statename2%	Description of tier 2
%statename3%	Description of tier 3
%statename4%	Description of tier 4
%counter%	Counter status of the job

Placeholders/Parameters	Description
%order-id%	Job ID
%order-number%	Job number
%order-description%	Description of job
%order-total%	Total amount of job
%order-progression%	Job progression

 All placeholders/parameters start and end with the character %.

## 4.2.2 Editing a job

1. Select the required job in the job overview.
2. Click on **Edit**.  
→ The **WINtoApplication task configuration** window appears.

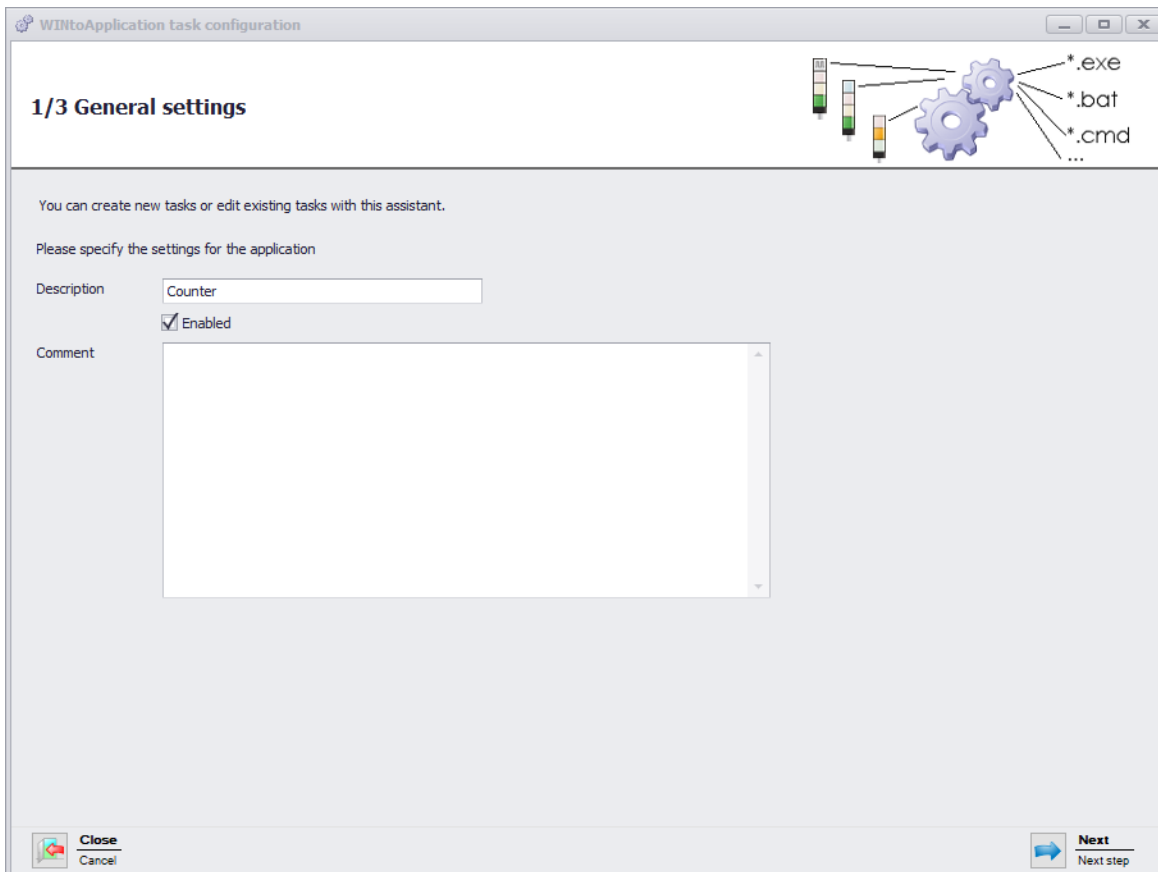

**1/3 General settings**

You can create new tasks or edit existing tasks with this assistant.

Please specify the settings for the application

Description:

Enabled

Comment:

**Close** **Cancel** **Next** Next step

3. Enter the name of the job in the **Description** field.
4. Enter an additional description of the job in the **Comment** field, if necessary.
5. Select **Enabled** if the job is to be immediately enabled once it has been created.
6. Click on **Next**.



→ The window to input the application settings appears.

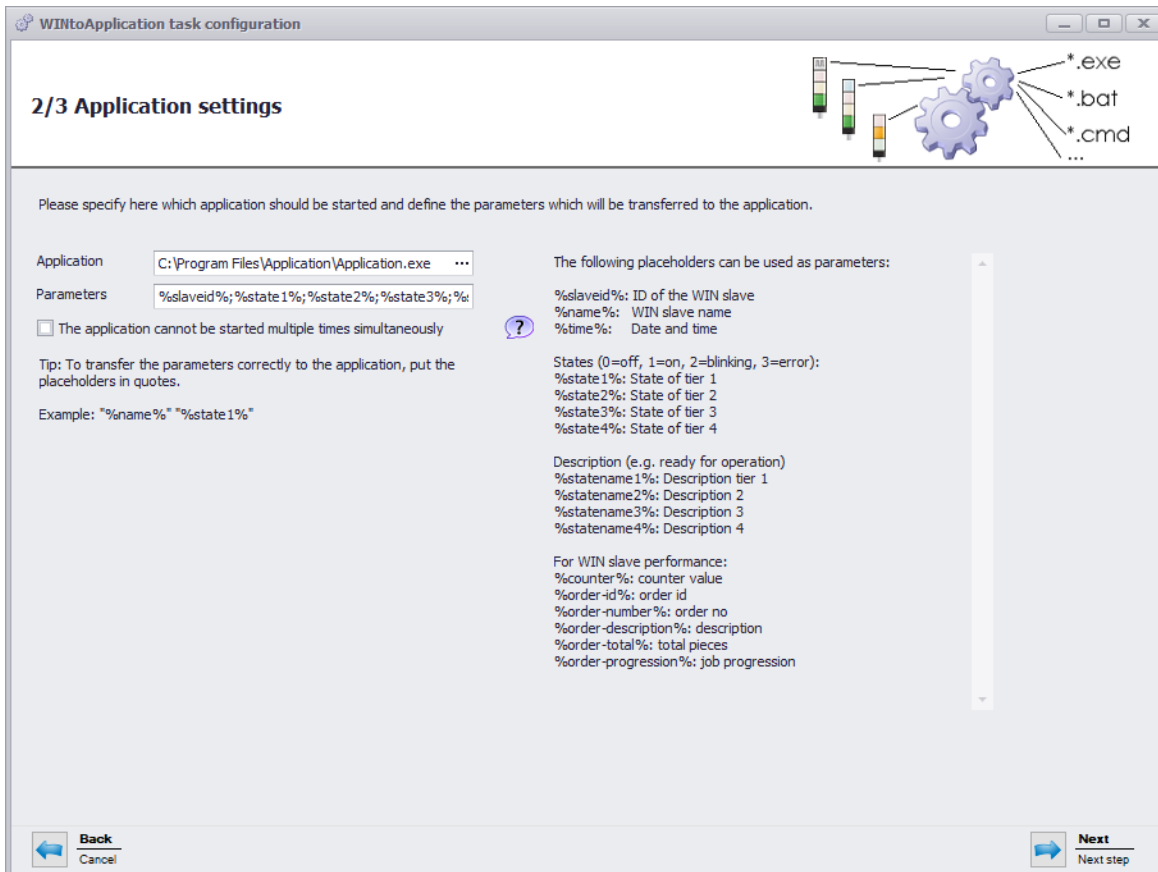

7. Click on ... in the **Application** field to select the external application.
8. In the **Parameters** field, enter the *Parameters* which are to be transmitted to the external application.
9. Enable **The application cannot be started multiple times simultaneously**, if required, to prevent the external application from being started several times simultaneously.



By enabling **The application cannot be started multiple times simultaneously**, the program waits until the external application has ended. The external application is then called up again.

Disable **The application cannot be started multiple times simultaneously** if applications expect a multiple start.

10. Click on **Next**.

→ The window to select the WIN slave appears.

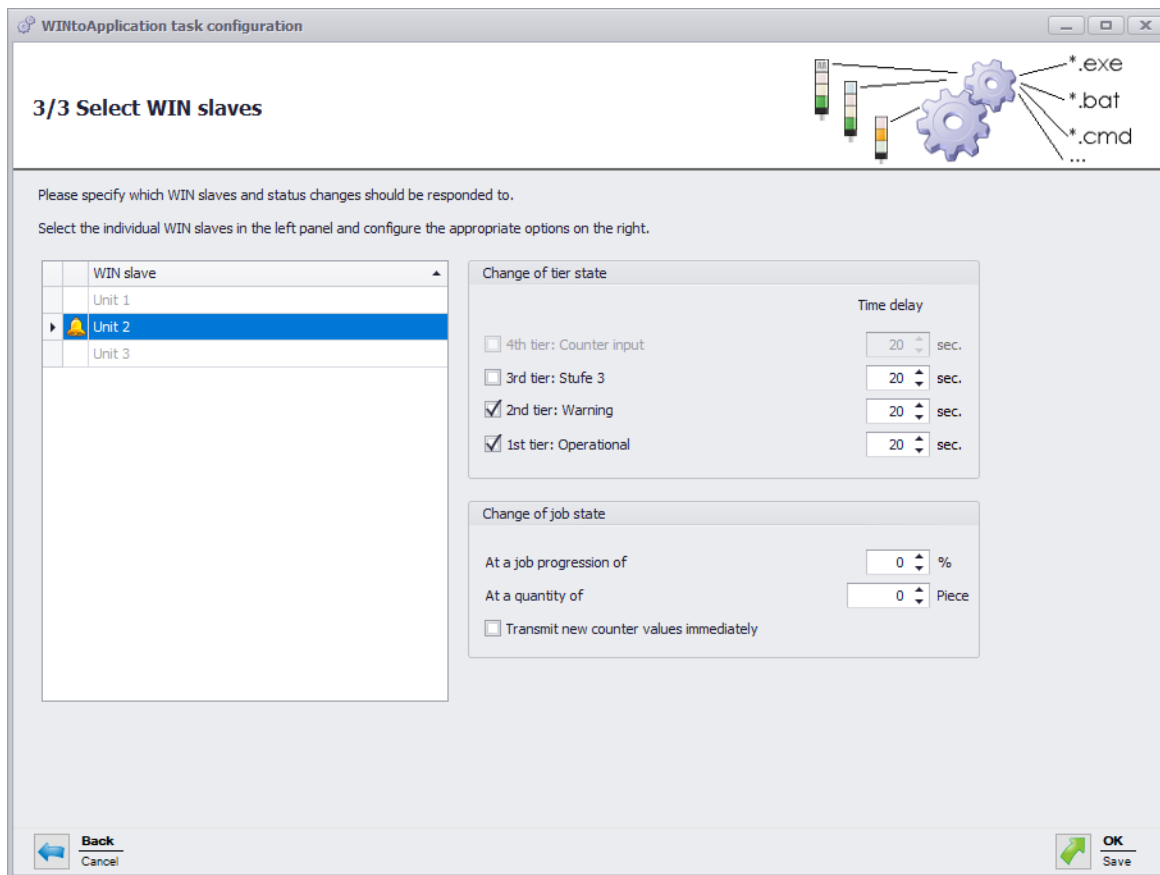

11. Select WIN slave, the status changes of which are to be transmitted, from the list of WIN slave.
12. In the **Change of tier state** area, select for which tiers the status changes are to be transmitted.
13. Enter a **Time delay** for each tier if necessary.

---

**i** The status change is only transmitted if the new status is unchanged during the defined **Time delay**. No status change is transmitted if the status has changed again within the **Time delay**.

---

14. In the **Change of job state** area, select at which job progression or at which quantity the status change is to be transmitted.
15. Enable **Transmit new counter values immediately** if every changed counter status is to be transmitted.

---

**i** The **Change of job state** area is only available if a WIN slave control is selected.

---

16. Click on **Next**.  
→ The window in which to create an Autostart shortcut appears.

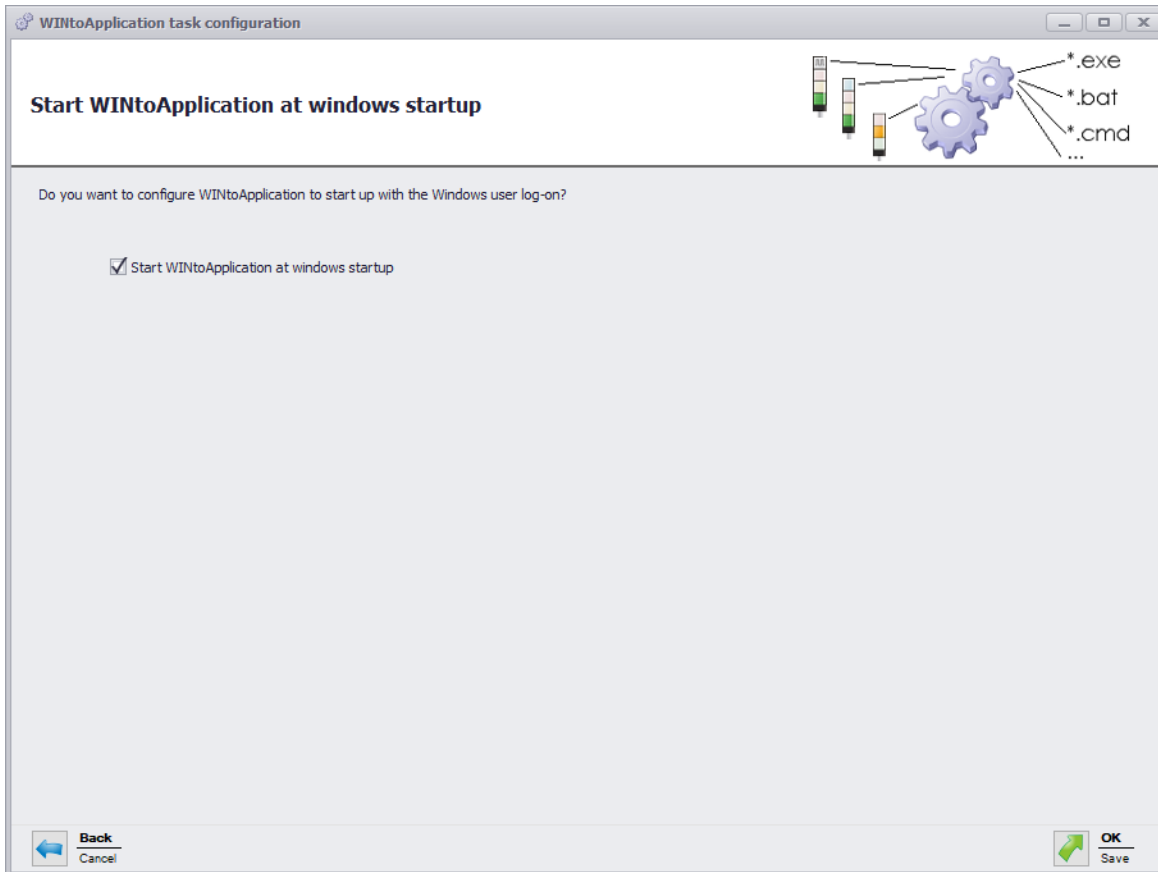

17. Enable **Start WINtoApplication at windows startup** if WINtoApplication is to be automatically started when the PC is started or after user login.
18. Click on **OK** to save the job.

#### 4.2.2.1 Placeholders/Parameters

The following placeholders/parameters are available:

Placeholders/Parameters	Description
%slaveid%	ID of the WIN slave
%name%	Description of the WIN slave
%time%	Date and time of status transmission
%reason%	Reason for status transmission
%state1%	Status of tier 1
%state2%	Status of tier 2
%state3%	Status of tier 3
%state4%	Status of tier 4
%statename1%	Description of tier 1
%statename2%	Description of tier 2
%statename3%	Description of tier 3
%statename4%	Description of tier 4
%counter%	Counter status of the job

Placeholders/Parameters	Description
%order-id%	Job ID
%order-number%	Job number
%order-description%	Description of job
%order-total%	Total amount of job
%order-progression%	Job progression

 All placeholders/parameters start and end with the character %.

### 4.2.3 Duplicating a job

1. Select the required job in the job overview.
2. Click on **Duplicate**.  
→ The **WINtoApplication task configuration** window appears.

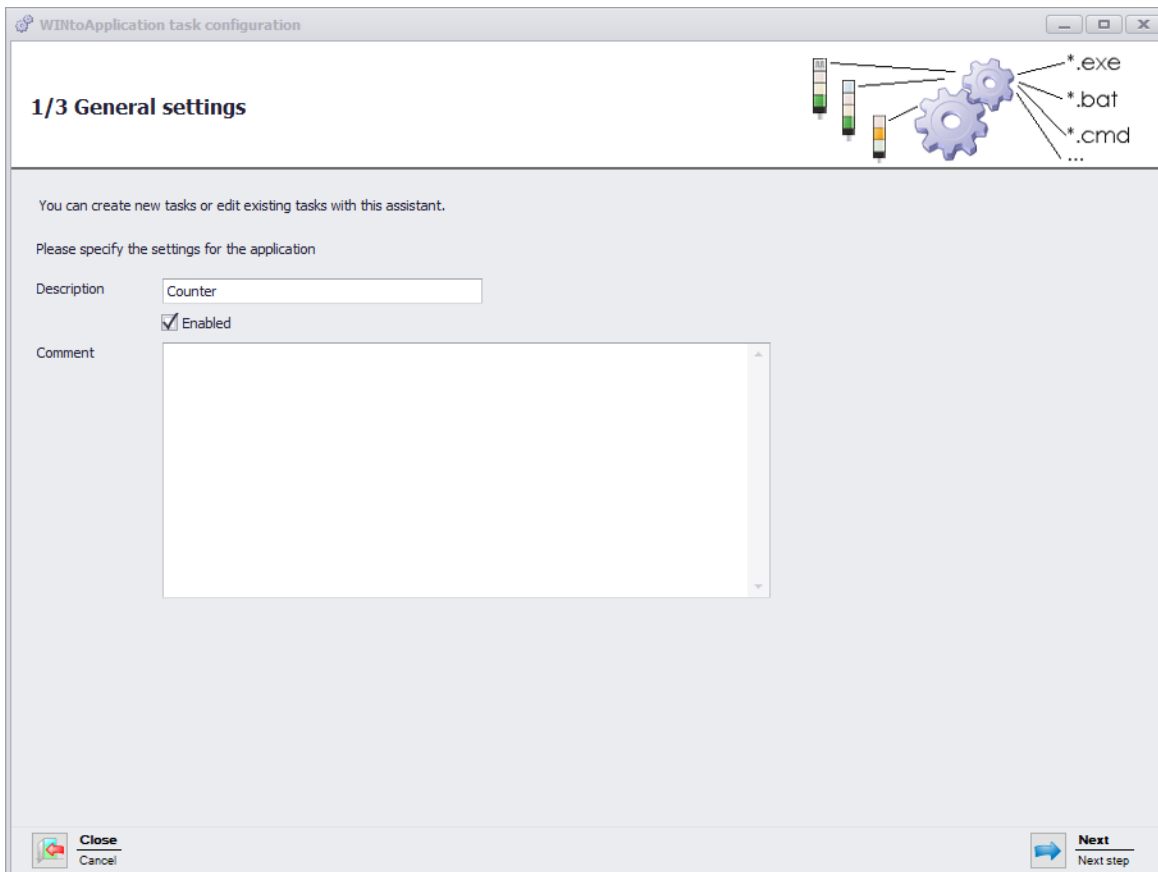

3. Enter the name of the job in the **Description** field.
4. Enter an additional description of the job in the **Comment** field, if necessary.
5. Select **Enabled** if the job is to be immediately enabled once it has been created.
6. Click on **Next**.

→ The window to input the application settings appears.

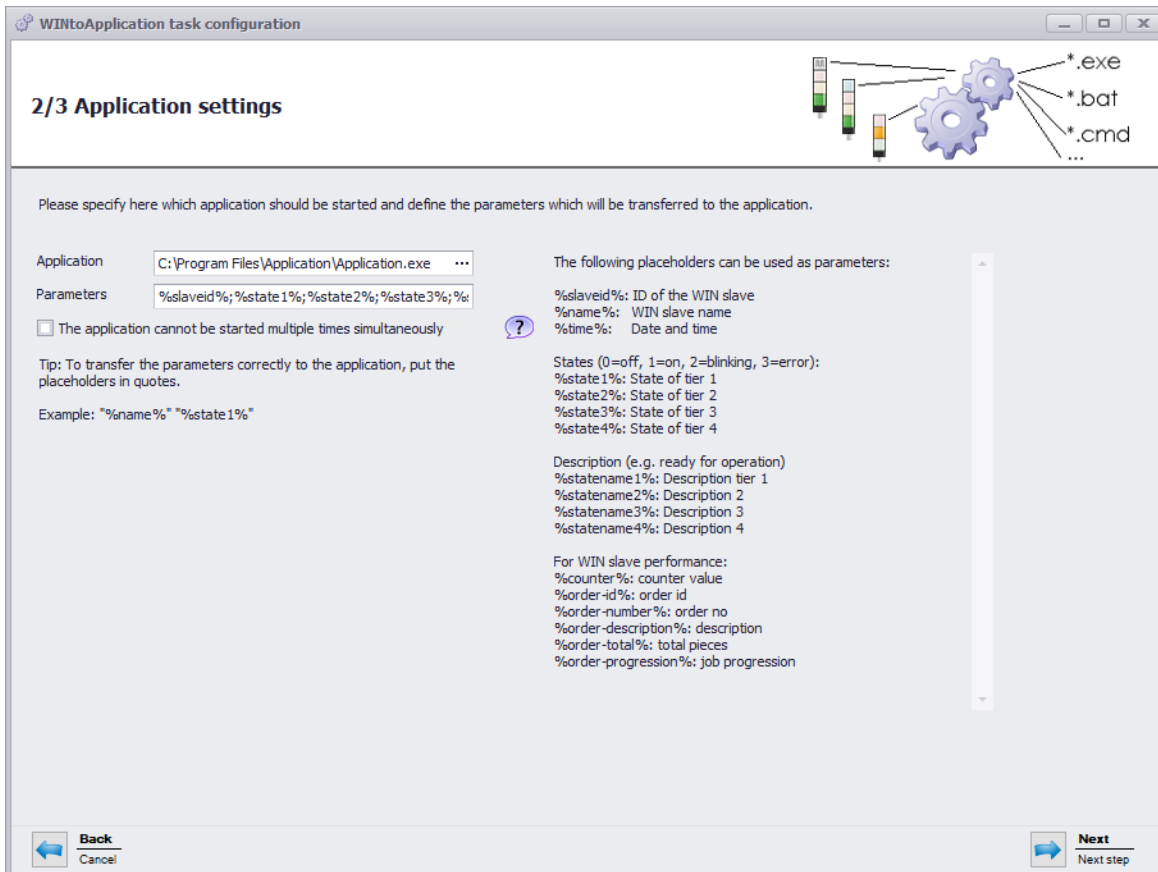

7. Click on ... in the **Application** field to select the external application.
8. In the **Parameters** field, enter the *Parameters* which are to be transmitted to the external application.
9. Enable **The application cannot be started multiple times simultaneously**, if required, to prevent the external application from being started several times simultaneously.



By enabling **The application cannot be started multiple times simultaneously**, the program waits until the external application has ended. The external application is then called up again.

Disable **The application cannot be started multiple times simultaneously** if applications expect a multiple start.

10. Click on **Next**.

→ The window to select the WIN slave appears.

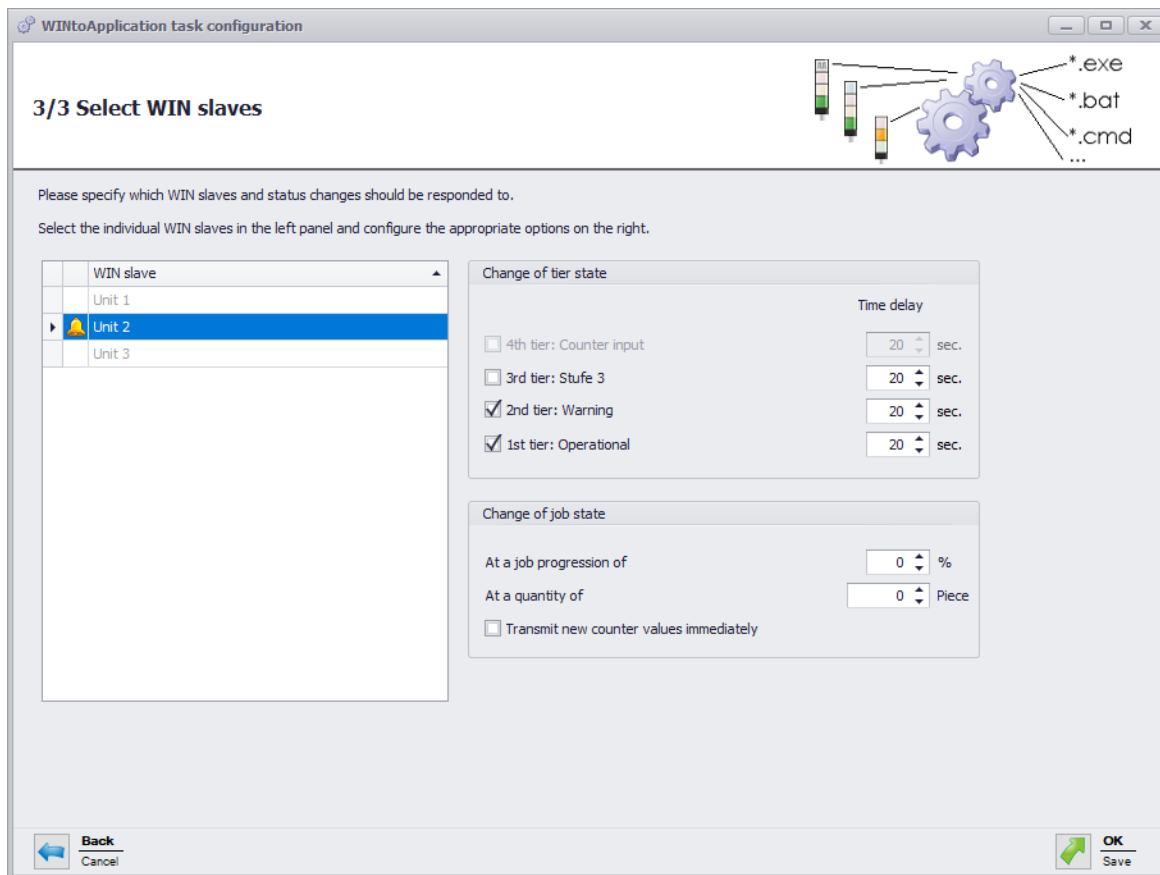

11. Select WIN slave, the status changes of which are to be transmitted, from the list of WIN slave.
12. In the **Change of tier state** area, select for which tiers the status changes are to be transmitted.
13. Enter a **Time delay** for each tier if necessary.

---

**i** The status change is only transmitted if the new status is unchanged during the defined **Time delay**. No status change is transmitted if the status has changed again within the **Time delay**.

---

14. In the **Change of job state** area, select at which job progression or at which quantity the status change is to be transmitted.
  15. Enable **Transmit new counter values immediately** if every changed counter status is to be transmitted.
- 

**i** The **Change of job state** area is only available if a WIN slave control is selected.

---

16. Click on **Next**.  
 → The window in which to create an Autostart shortcut appears.

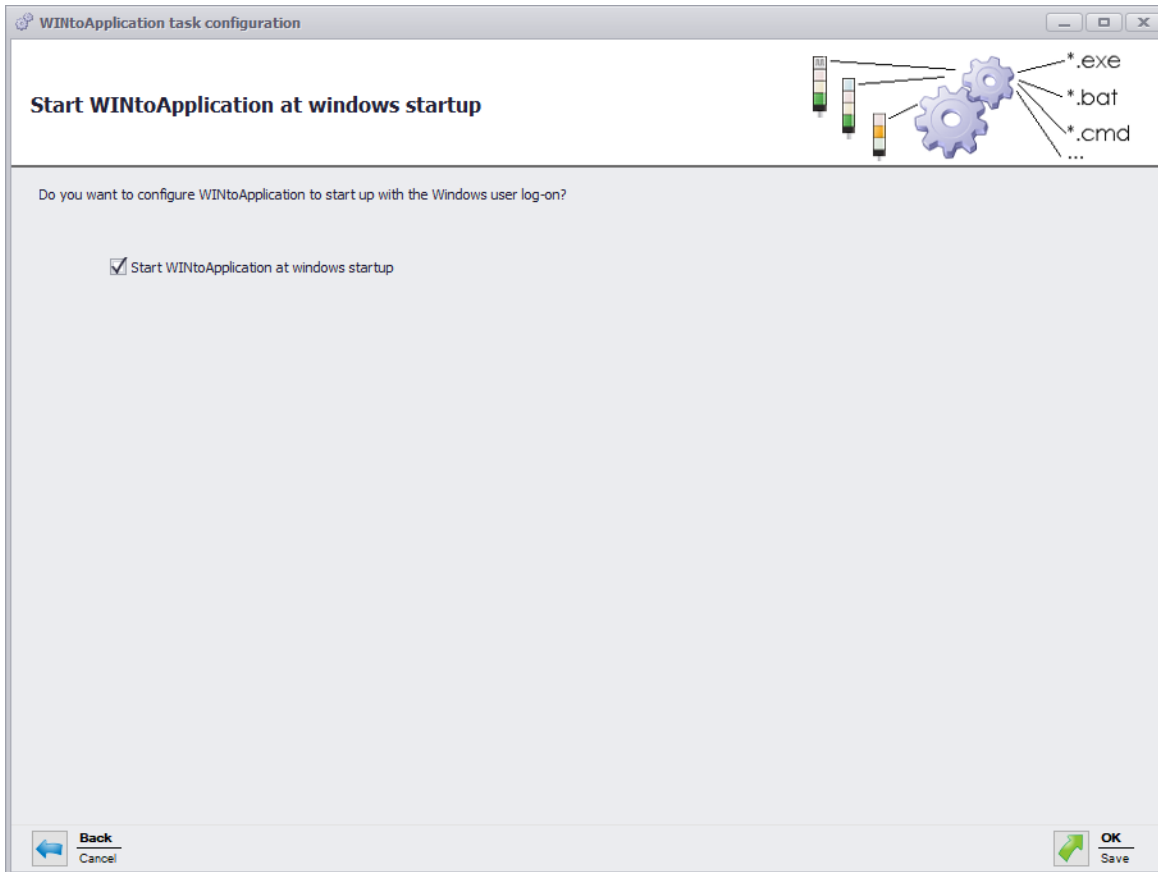

17. Enable **Start WINtoApplication at windows startup** if WINtoApplication is to be automatically started when the PC is started or after user login.
18. Click on **OK** to save the job.

#### 4.2.3.1 Placeholders/Parameters

The following placeholders/parameters are available:

Placeholders/Parameters	Description
%slaveid%	ID of the WIN slave
%name%	Description of the WIN slave
%time%	Date and time of status transmission
%reason%	Reason for status transmission
%state1%	Status of tier 1
%state2%	Status of tier 2
%state3%	Status of tier 3
%state4%	Status of tier 4
%statename1%	Description of tier 1
%statename2%	Description of tier 2
%statename3%	Description of tier 3
%statename4%	Description of tier 4
%counter%	Counter status of the job

Placeholders/Parameters	Description
%order-id%	Job ID
%order-number%	Job number
%order-description%	Description of job
%order-total%	Total amount of job
%order-progression%	Job progression

 All placeholders/parameters start and end with the character %.

## 4.2.4 Enabling or disabling individual jobs

1. Select the required job in the job overview and enable or disable the checkbox in the **enabled** column.

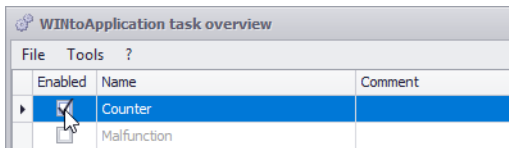

 The statuses will continue to be monitored if a job is disabled. Status transmission to the external application is stopped.

## 4.2.5 Enabling or disabling all jobs

1. Right-click on the WINtoApplication symbol in the information section.

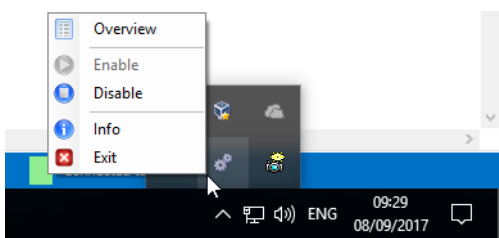

2. Select **Enable** or **Disable** in the menu.

 The statuses will continue to be monitored if the jobs are disabled. Status transmission to the external application is stopped.



## 4.2.6 Deleting jobs

1. Select the required job in the job overview.
2. Click **Delete**.
3. Confirm the prompt with **Yes**.

## 4.2.7 Exporting jobs

An export can be created to use the created jobs on another PC or for another user.

1. Click on **Export** in the **Tools** menu.  
→ The **Export task configuration** window appears.

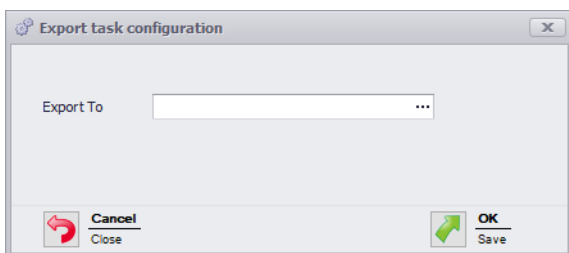

2. Click on ... in the **Export to** field.
3. Select the filename and storage location for the export file.
4. Click on **Save**.
5. Click on **OK**.

## 4.2.8 Importing jobs

1. Click on **Import** in the **Tools** menu.  
→ The **Import task configuration** window appears.

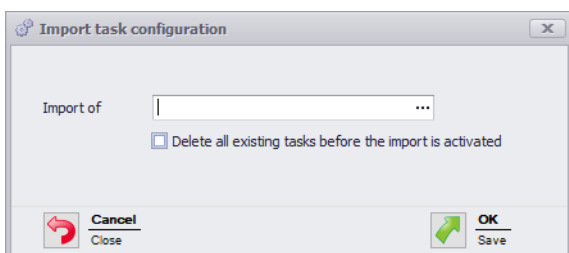

2. Enable **Delete all existing tasks before the import is activated** if all existing jobs are to be deleted before the import.
3. Click on ... in the **Import of** field and select the import file.
4. Confirm the prompt with **Yes**.

## 4.2.9 History

A history log is automatically created to understand previous processes better and identify errors. This indicates which parameters have been transmitted to which external application.

To display the history log of a job:

1. Hover your cursor over the **State** column to select the required job in the job overview.

## 4.2.10 Settings

The processing of all jobs can be started and a startup shortcut created for the WINtoApplication in Settings.

1. Click on **Settings** in the **Tools** menu.  
→ The **Settings** window appears.

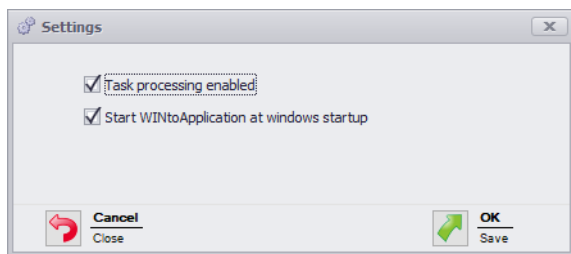

2. Enable **Start task processing** to start the processing of all tasks.
3. Enable **Start WINtoApplication at windows startup** if WINtoApplication is to be automatically started when the PC is started or after user login.
4. Click on **OK** to save the job.

## 4.2.11 Exiting WINtoApplication

To move WINtoApplication into the system tray:

1. Click on **Close overview** in the **File** menu or close the WINtoApplication job overview by clicking on

To fully exit the WINtoApplication and the execution of all jobs:

1. Right-click on the WINtoApplication symbol in the information section.

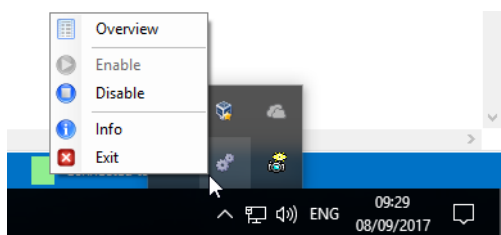

2. Select **Exit** in the pop-up menu.
3. Confirm the prompt with **Yes**.

### 4.3 WERMA-WIN CLI Tool

The WERMA-WIN CLI Tool (command-line interface tool) makes it possible to automate WIN slave control with different commands using an external application.

To call up the WERMA-WIN CLI tool:

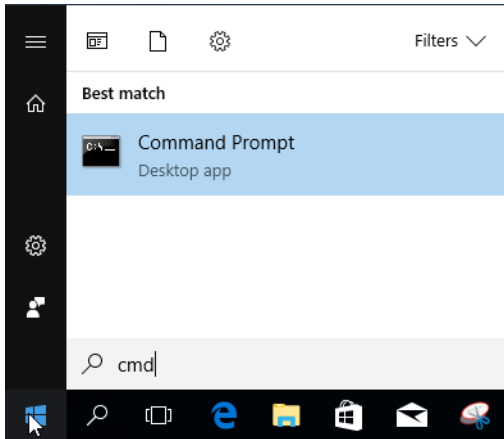

1. Open the command line.



2. Enter the path for WERMA-WIN in the command line (e.g. `cd C:\Program Files (x86)\WERMA-WIN-4`).

The following functions are available:

Function	Description	Command line entry/example
<b>/help</b>	Shows all possible functions.	<code>WIN-CLI.exe /help</code>
<b>/server</b>	Adapts the WERMA-WIN server's port and server. The default setting is the server setting of WERMA-WIN.	<code>/server &lt;server&gt;[:&lt;port&gt;]</code> Example: <code>WIN-CLI.exe /server Winserver01:10710</code>



Function	Description	Command line entry/example															
<b>/switchcontrol</b>	Controls the WIN slave control.	<code>/switchcontrol &lt;slave&gt; &lt;tier&gt; &lt;state&gt;</code>															
		<table border="1"> <thead> <tr> <th>&lt;slave&gt;</th> <th>&lt;tier&gt;</th> <th>&lt;state&gt;</th> </tr> </thead> <tbody> <tr> <td>"id:&lt;slave-id&gt;"</td> <td>1: Tier1</td> <td>0: Off</td> </tr> <tr> <td>"macid:&lt;slave-macid&gt;"</td> <td>2: Tier2</td> <td>1: On</td> </tr> <tr> <td>"name:&lt;slave-name&gt;"</td> <td>3: Tier3</td> <td>2: Blinking</td> </tr> <tr> <td></td> <td>4: Tier4</td> <td></td> </tr> </tbody> </table>	<slave>	<tier>	<state>	"id:<slave-id>"	1: Tier1	0: Off	"macid:<slave-macid>"	2: Tier2	1: On	"name:<slave-name>"	3: Tier3	2: Blinking		4: Tier4	
		<slave>	<tier>	<state>													
		"id:<slave-id>"	1: Tier1	0: Off													
"macid:<slave-macid>"	2: Tier2	1: On															
"name:<slave-name>"	3: Tier3	2: Blinking															
	4: Tier4																
Example:	 On WIN-CLI.exe /switchcontrol "id:7" 2 1																
	Blinking WIN-CLI.exe /switchcontrol "name:machine1" 2 -2																
	Off WIN-CLI.exe /switchcontrol "macid:03162D" 2 0																
<b>/export-slaves</b>	Create a CSV file with all WIN slave from the WERMA-WIN database in the selected <file> location.	<code>/export-slaves &lt;file&gt;</code> Example: WIN-CLI.exe /export-slaves "C:\test.csv"															

Exit Code	Description
0 .	Command successfully executed
1 .	no command is executed, help message displayed
-1 .	an exception occurred, see command line output

## 5 Fault diagnostics

Possible errors and the current status of the WERMA-WIN devices are displayed by the respective LEDs.

### 5.1 WIN slave, WIN slave performance, WIN slave control

LED	Description
Green 	Radio connection established to the WIN master.
Red 	No radio connection possible to the WIN master.

### 5.2 WIN slave control

The blue state LEDs shows the status of the outputs.

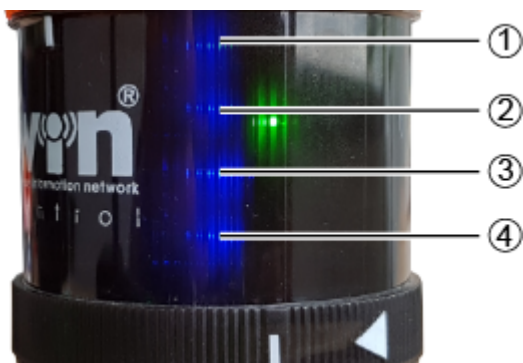

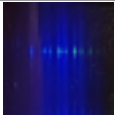

Item	Description
1	Tier 4 output
2	Tier 3 output
3	Tier 2 output
4	Tier 1 output



LED	Description
 On	Output was switched manually or by a switching rule.
Off	Output was not switched.

 The blue state LEDs only light up if **Activate additional pins 2 to 5** option was selected during *configuration* of the switching behaviour of the WIN slave control.

### 5.3 WIN master

LED	Description
Green 	Radio connection established to the WIN slave.
Red 	No radio connection possible to the WIN slave.

## 5.4 WIN ethernet master

LED Ethernet connection	Description	
Green		
	On	Connection established to the network.
	Off	No connection possible to the network.
	Blinking	Network activity
Yellow		
	On	Connection established to WERMA-WIN.
	Off	No connection established to WERMA-WIN.

## 6 Software update

As soon as a software update is available, it can be downloaded and installed from the WERMA homepage.

1. Click **Software update** in the toolbar.  
→ The Download area on the WERMA homepage appears.
2. Download the update file and install on the PC.



If several workplaces are accessing a common WERMA-WIN database, you first need to install the software update on the PC with the WERMA-WIN database (server PC). An appropriate message appears if the installation is first started on a client PC.

The software update must be run on all PCs connected to the common WERMA-WIN database.

---



## 7 System requirements

The system requirements differ for the server PC and client PCs.

	Server PC	Client PC
Installed software components	Microsoft SQL server WERMA-WIN WERMA-WIN database Device driver for hardware	WERMA-WIN Network connection to Microsoft SQL server with the WERMA-WIN database Device driver for hardware
Processor	Pentium III compatible processor or higher Dual Core processor is recommended	
Minimum RAM	2 GB	1 GB
Free hard disk space (recommended)	8 GB	8 GB
USB port	Required for the hardware configuration. The configuration can also be used on the Client PC.	
Screen resolution	At least: 1280 x 1024 Recommended: 1920 x 1080 or higher Scaling of font size (DPI) 100% (96 DPI)	
Microsoft.NET Framework 4.5.2	Automatically installed when installing WERMA-WIN.	
Supported operating systems	Windows 8 Windows 8.1 Windows Server 2008 R2 SP1 Windows Server 2012 Windows Server 2012 R2 Windows 10 Windows Server 2016	
Supported SQL server	Microsoft SQL Server 2008 SP4 Microsoft SQL Server 2008 R2 SP3 Microsoft SQL Server 2012 SP4 Microsoft SQL Server 2014 SP2 (recommended) Microsoft SQL Server 2016 SP2 Microsoft SQL Server 2017	

 Unless otherwise specified, the 32-bit (x86) and 64-bit (x64) versions are supported.



Supported operating systems and SQL Server versions are only supported as long as Microsoft also supports them through the Microsoft Support **lifecycle**.

The automatic installation of the database onto a domain controller is not supported. Manual installation is possible.

Installation of the Windows server core and nano server is not supported.

The Windows server role **Remote desktop services** is not supported on the server PC.

Only Microsoft SQL server editions Express, Workgroup, Standard, Enterprise and Data-center for Windows, as well as the supplied Microsoft SQL Server 2014 Express database are supported.

In each case, only the latest Microsoft Windows and Microsoft SQL server service packs are supported.

Microsoft Server 2019 and Microsoft SQL Server 2019 have not been tested in all configurations. The tests to date have been successful.

---

## 7.1 Network stability and security

---



WERMA recommends that you only operate WERMA-WIN in a reliable LAN environment (TCP/IP network). The function or performance of WERMA-WIN could be impaired in an unstable or insecure network.

---

## 8 Keyboard shortcuts

Keyboard shortcuts let you work more quickly with WERMA-WIN. You can select from general keyboard shortcuts and shortcuts that apply to the specific module.

### 8.1 Windows standard

Keyboard shortcut	Description
F1	Display Help.
F5	Refresh active window.
F10	Enable menu bar.
F11	Maximise active window.
CTRL + F1	Minimise menu bar.
CTRL + F4	Close active document.
CTRL + A	Select all items.
CTRL + C	Copy selected item.
CTRL + D	Delete selected item.
CTRL + N	Open new window.
CTRL + O	Open document / file.
CTRL + P	Print document.
CTRL + V	Paste selected item.
CTRL + W	Close current window.
CTRL + X	Cut selected item.
CTRL + Z	Undo action.
ALT + F4	Close active item or exit active app.
ALT + P	Display preview window.
DELETE	Delete selected item.

### 8.2 General

Keyboard shortcut	Description
F1	Call up manual.
F2	Call up contact page.
F3	Call up Information window.
CTRL + F4	Close active document.
CTRL + F6	Call up <b>Control station</b> main view.
CTRL + F7	Call up <b>Productivity</b> main view.
CTRL + F8	Call up <b>Runtime</b> main view.
CTRL + F9	Call up <b>Job</b> main view.

Keyboard shortcut	Description
CTRL + F10	Call up <b>Control</b> main view.
CTRL + F11	Call up <b>Routing</b> main view.
CTRL + F12	Call up <b>Runtime</b> module with WIN slave selection.
ALT + F1	Call up <b>Job quick start</b> window.

### 8.3 Control station

Keyboard shortcut	Description
F1	Call up manual.
F2	Call up contact page.
F3	Call up Information window.
F8	Add WIN slave.
F9	Select background.
F11	Start full screen mode.
F12	Generate report.
CTRL + F4	Close active document.
ALT + F1	Call up <b>Job quick start</b> window.
ALT + F6	Call up <b>Activation</b> window.
ALT + F7	Call up <b>Settings</b> window.
ALT + F8	Search for software update.
ESC	Exit full screen mode.

### 8.4 Productivity

Keyboard shortcut	Description
F1	Call up manual.
F2	Call up contact page.
F3	Call up Information window.
F7	Show combined productivity.
F8	Add WIN slave.
F9	Select background.
F11	Start full screen mode.
F12	Generate report.
CTRL + F4	Close active document.
ALT + F1	Call up <b>Job quick start</b> window.
ALT + F6	Call up <b>Activation</b> window.
ALT + F7	Call up <b>Settings</b> window.
ALT + F8	Search for software update.
ESC	Exit full screen mode.

## 8.5 Runtime

Keyboard shortcut	Description
F1	Call up manual.
F2	Call up contact page.
F3	Call up Information window.
F7	Call up the <b>Status</b> view.
F8	Call up the <b>Quantity</b> view.
F9	Call up the <b>Combined</b> view.
F11	Start full screen mode.
F12	Generate report.
CTRL + F4	Close active document.
ALT + F1	Call up <b>Job quick start</b> window.
ALT + F6	Call up <b>Activation</b> window.
ALT + F7	Call up <b>Settings</b> window.
ALT + F8	Search for software update.
ESC	Exit full screen mode.

## 8.6 Job

Keyboard shortcut	Description
F1	Call up manual.
F2	Call up contact page.
F3	Call up Information window.
F9	Show Auto jobs.
F12	Generate report.
CTRL + E	Edit job.
CTRL + I	Import job list.
CTRL + N	Enter job.
CTRL + Q	End job.
CTRL + R	Start job.
CTRL + F4	Close active document.
ALT + F1	Call up <b>Job quick start</b> window.
ALT + F2	Start with 1st piece
ALT + F3	Start with job input
ALT + F6	Call up <b>Activation</b> window.
ALT + F7	Call up <b>Settings</b> window.
ALT + F8	Search for software update.
ESC	Exit full screen mode.
DELETE	Delete job.

## 8.7 Control

Keyboard shortcut	Description
F1	Call up manual.
F2	Call up contact page.
F3	Call up Information window.
CTRL + F4	Close active document.
CTRL + D	Duplicate rule.
CTRL + E	Edit rule.
CTRL + N	Create new rule (assistant).
CTRL + Q	Disable rule.
CTRL + R	Enable rule.
ALT + F1	Call up <b>Job quick start</b> window.
ALT + F6	Call up <b>Activation</b> window.
ALT + F7	Call up <b>Settings</b> window.
ALT + F8	Search for software update.
DELETE	Delete rule.
CTRL + Shift + NCTRL + N	Create new rule (Expert).

## 8.8 Routing

Keyboard shortcut	Description
F1	Call up manual.
F2	Call up contact page.
F3	Call up Information window.
F12	Call up the <b>Connection status</b> window.
CTRL + F4	Close active document.
ALT + F1	Call up <b>Job quick start</b> window.
ALT + F6	Call up <b>Activation</b> window.
ALT + F7	Call up <b>Settings</b> window.
ALT + F8	Search for software update.

## 9 FAQ – Frequently Asked Questions

### On which frequency band does the WIN system run?

WIN runs in the frequency band 868,0 – 868,6 MHz. Short-range radio system has no effect on existing Wi-Fi or Bluetooth networks.

### Can WIN be run on different radio channels?

Yes, you can choose from four radio channels. You should only run one WIN master per channel.

The channels have the following frequencies:

Channel	Frequency
1	868,15 MHz
2	868,25 MHz
3	868,35 MHz
4	868,45 MHz

### Why are different radio channels needed? When should the radio channel be changed?

If more than one WIN master is run on a channel, it can cause transmission problems between the systems. This can be seen by the frequency connection errors. In this case, run the WIN master on *different radio channels*.

### How can I increase the range?

Every WIN master possesses a repeater function, which can be used to increase the range between the WIN master and the WIN slave. Every WIN slave can thereby establish a connection to the WIN master using a maximum of 2 WIN slave (repeaters).

### Is the radio transmission encrypted?

The WIN system is equipped with several protection mechanisms, which prevent the radio transmission being intercepted. However, unrestricted security against interception cannot be guaranteed. In addition, no confidential data from the WIN system is transmitted wirelessly.

### How often does the WIN slave transmit the signal status to the WIN master?

If the status of the signal tower changes, the WIN slave sends this new signal status to the WIN master within a response time of up to 5 seconds. If the signal status does not change, the WIN slave transmits the signal status every 15 seconds to the WIN master.

### Why can the WIN slave not establish a connection to the WIN master?

Check the following points:

- The WIN master (USB) must be connected to the PC by USB. The red or green LED must light up.
- The WIN slave must be connected to a power supply. The red or green LED must light up.
- The WIN slave must be configured.
- The radio connection must not be disrupted.
- If the WIN master has been configured on another radio channel, the assigned WIN masters have to be reconfigured on the WIN master.

### There are frequent connection errors to the WIN slaves. What can be done?

- Data will only be logged while WERMA-WIN is running. WERMA-WIN must be running in the monitoring period.
- The connection quality can be checked in the **Routing module**. The use of additional WIN slaves as repeaters is recommended if connection lines appear red. A WIN slave must be positioned at the critical point for this purpose.
- There needs to be a permanent 24 V power supply connected to Pin 5 on every WIN slave.

#### **Why does the PC not recognise the WIN master?**

- WERMA-WIN must be installed and started on the PC.
- Disconnect the USB connection to the WIN slave and reconnect it.
- *Manually install the driver.*
- The Windows Service **WERMA WIN 4 Connector Service** must have started.

#### **Why can WERMA-WIN not be installed?**

Administrator rights are needed to install WERMA-WIN.

#### **How many WIN slaves can be monitored by one WIN master?**

Up to 50 WIN slaves can be monitored.

#### **What happens if more than 50 WIN slaves are connected?**

If more than 50 WIN slaves are connected, this can lead to transmission errors between the WIN slaves.

#### **How many signal elements can be monitored per WIN slave?**

Up to 4 elements can be monitored per WIN slave. Up to 8 statuses can be monitored using blink recognition.

#### **How many signal elements can be monitored per WIN slave performance?**

Up to 3 elements can be monitored per WIN slave performance. Up to 6 statuses can be monitored using blink recognition.

A tier is essential for the counter input.

You can monitor up to 2 elements or a maximum of 4 statuses if a tier is also fitted with the job input.

#### **How many strokes per minute (e.g. with punching) can WERMA-WIN count or record?**

WERMA-WIN can count up to a maximum of 600 strokes per minute. The timer of the machine or control must be increased (> 100 ms) to detect the correct quantity of the machine.

#### **Why does the WIN master light up red?**

The WIN master is ready for operation but is not connected to a WIN slave.

#### **Why is the red state LED on the WIN slave lit?**

The WIN slave is ready for operation but is not connected to a WIN master.

#### **What is the maximum permissible USB cable length between the WIN master and PC?**



The cable length should not exceed 3 metres. The maximum cable length can be increased using a USB hub.

**Can the collected data be further processed?**

Yes, all data is stored in a Microsoft SQL server database. The data can be read (Microsoft Excel, Microsoft Access ...). Avoid changing the database to avoid loss of data.

**What steps need to be taken with time changes?**

A time change can lead to a loss of data. If the system time is synchronised several times (e.g. automatically with a server), then we would recommend doing so outside the monitoring period.

**Can a WIN slave performance be configured to have the same configuration as a WIN slave?**

No, a WIN slave performance always needs one tier allocated to the counter input.

**What must be considered when installing WERMA-WIN?**

The system requirements need to be observed. Administrator rights are needed to install WERMA-WIN.

**How fast can a WIN slave performance count on the tier with counter input?**

The counter pulse can be up to 10 Hz.

**Can blink recognition be set up for all tiers of the WIN slave performance?**

No, blink recognition cannot be selected for the tier with counter input or for the tier with job input.

**Is it possible to read job information from an ERP system into WERMA-WIN?**

Yes, you need to create a CSV file with the correct format for this. This can then be imported into WERMA-WIN.

**Are there any keyboard shortcut functions in the software?**

Yes, WERMA-WIN can be quickly operated using the keyboard with a number of different *keyboard shortcuts*.

**What must be observed when saving data to the WERMA-WIN database?**

The PC to which the WIN master is connected by a USB cable must be continuously in operation. The PC on which the WERMA-WIN database is installed must be in operation around the clock. The **WERMA WIN 4 Server Service** and the **WERMA WIN 4 Connector Service** must have been started.

**Why is the WERMA WIN 4 Connector Service needed?**

The service runs in the background when the PC (client and server) is running. The collected WERMA-WIN data from the WIN master is transmitted to the **WERMA WIN 4 Server Service** without WERMA-WIN being started and a user being logged in.

**What is the WERMA WIN 4 Server Service needed for?**

The service runs in the background when the PC (client and server) is running. The collected WERMA-WIN data from the WIN master is transmitted to the **WERMA WIN 4 Server Service** without WERMA-WIN being started and a user being logged in.

#### **Can energy-saving mode or hibernation mode be enabled on a PC with WERMA-WIN?**

WERMA recommends disabling energy-saving mode and hibernation state for the following uses:

- PC with the WERMA-WIN database
- PC with the **WERMA WIN 4 Server Service**
- PC with a connected WIN master (USB)

#### **Can the WIN ethernet master be operated over the internet?**

From a technical perspective, the WIN ethernet master can be operated over the internet.

In spite of basic security measures, we would nevertheless strongly recommend in this case providing additional security for the connection to the WIN ethernet master, for example via an encrypted VPN connection.